



**FlinInfini Turbo MPPT Plus 6kW-48V
Solar Hybrid Inverter**

USER MANUAL

Table Of Contents

ABOUT THIS MANUAL	1
Purpose	1
Scope	1
SAFETY INSTRUCTIONS	1
INTRODUCTION	2
Product Overview.....	3
INSTALLATION	4
Unpacking and Inspection	4
Preparation	4
Installing the Unit.....	4
Battery Connection.....	7
AC Input/Output Connection.....	8
PV Connection	10
Communication Connection.....	11
BMS Communication.....	11
Dry Contact Signal	12
OPERATION	13
LCD Display Icons.....	13
LCD Setting	19
Operating Mode Description	24
SPECIFICATIONS	26
TROUBLE SHOOTING	27
Appendix I: Parallel function	28
Appendix II: BMS Communication Installation	44
Appendix III: The Wi-Fi Operation Guide	51
Introduction	51
Energy-Mate App	51

ABOUT THIS MANUAL

Purpose

This manual describes the assembly, installation, operation and troubleshooting of this unit. Please read this manual carefully before installations and operations. Keep this manual for future reference.

Scope

This manual provides safety and installation guidelines as well as information on tools and wiring.

SAFETY INSTRUCTIONS



WARNING: This chapter contains important safety and operating instructions. Read and keep this manual for future reference.

1. Before using the unit, read all instructions and cautionary markings on the unit, the batteries and all appropriate sections of this manual.
2. **CAUTION** --To reduce risk of injury, charge only deep-cycle lead acid type rechargeable batteries. Other types of batteries may burst, causing personal injury and damage.
3. Do not disassemble the unit. Take it to a qualified service center when service or repair is required. Incorrect re-assembly may result in a risk of electric shock or fire.
4. To reduce risk of electric shock, disconnect all wirings before attempting any maintenance or cleaning. Turning off the unit will not reduce this risk.
5. **CAUTION** – Only qualified personnel can install this device with battery.
6. **NEVER** charge a frozen battery.
7. For optimum operation of this inverter/charger, please follow required spec to select appropriate cable size. It's very important to correctly operate this inverter/charger.
8. Be very cautious when working with metal tools on or around batteries. A potential risk exists to drop a tool to spark or short circuit batteries or other electrical parts and could cause an explosion.
9. Please strictly follow installation procedure when you want to disconnect AC or DC terminals. Please refer to INSTALLATION section of this manual for the details.
10. Fuses are provided as over-current protection for the battery supply.
11. GROUNDING INSTRUCTIONS -This inverter/charger should be connected to a permanent grounded wiring system. Be sure to comply with local requirements and regulation to install this inverter.
12. NEVER cause AC output and DC input short circuited. Do NOT connect to the mains when DC input short circuits.
13. **Warning!!** Only qualified service persons are able to service this device. If errors still persist after following troubleshooting table, please send this inverter/charger back to local dealer or service center for maintenance.

INTRODUCTION

This hybrid PV inverter can provide power to connected loads by utilizing PV power, utility power and battery power.

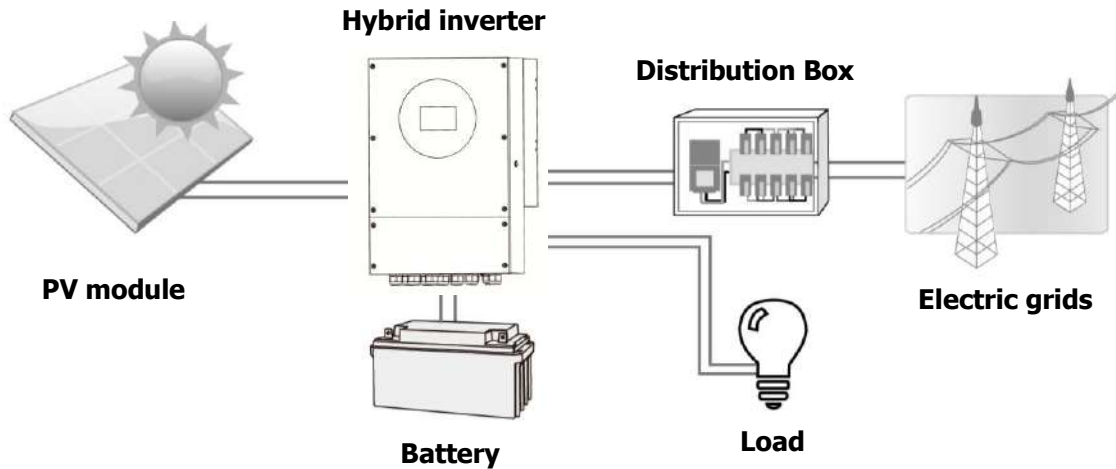
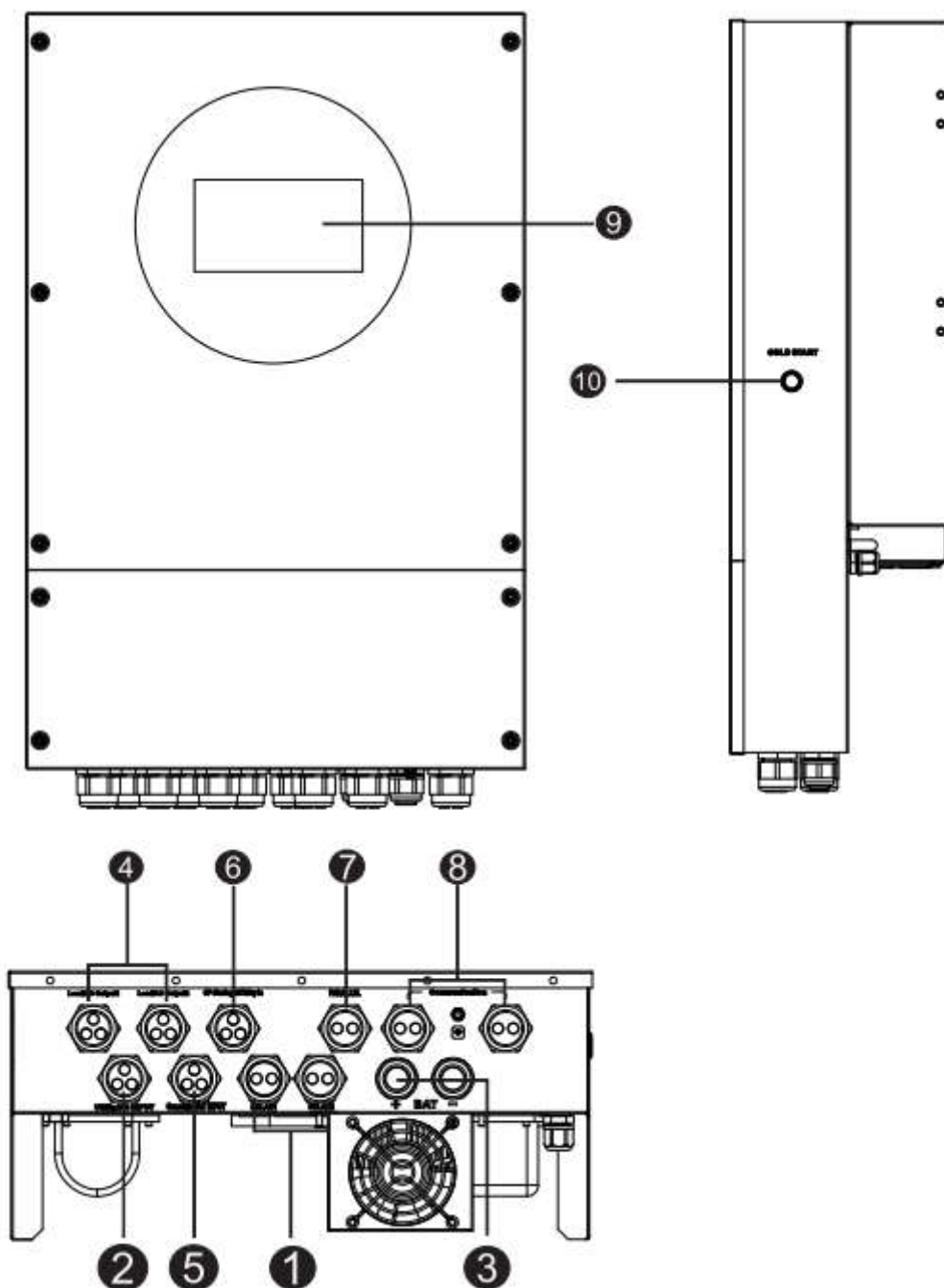

Figure 1 Basic hybrid PV System Overview

Depending on different power situations, this hybrid inverter is designed to generate continuous power from PV solar modules (solar panels), battery, and the utility. When MPP input voltage of PV modules is within acceptable range (see specification for the details), this inverter is able to generate power to feed the grid (utility) and charge battery. **Never connect the positive and negative terminals of the solar panel to the ground.** See Figure 1 for a simple diagram of a typical solar system with this hybrid inverter.

Product Overview



NOTE: For parallel model installation and operation, please check separate parallel installation guide for the details.

1. PV connectors
2. AC Grid connectors
3. Battery connectors
4. AC output connectors
5. AC Generator connectors
6. Sharing current ports & external sensor ports
7. Parallel communication ports
8. Dry contact/USB/RS-232/BMS communication ports
9. LCD display
10. Cold start button

INSTALLATION

Unpacking and Inspection

Before installation, please inspect the unit. Be sure that nothing inside the package is damaged. You should have received the following items inside of package:

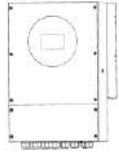

Inverter unit



Software CD



Manual



RS-232 cable



Parallel communication cable



Current sharing cable



Mounting screws

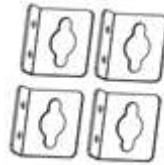

Mounting plate



WiFi antenna



DC terminals
(Only for 8.6KW,10.6KW)

Preparation

Before connecting all wirings, please take off bottom cover by removing four screws as shown below.

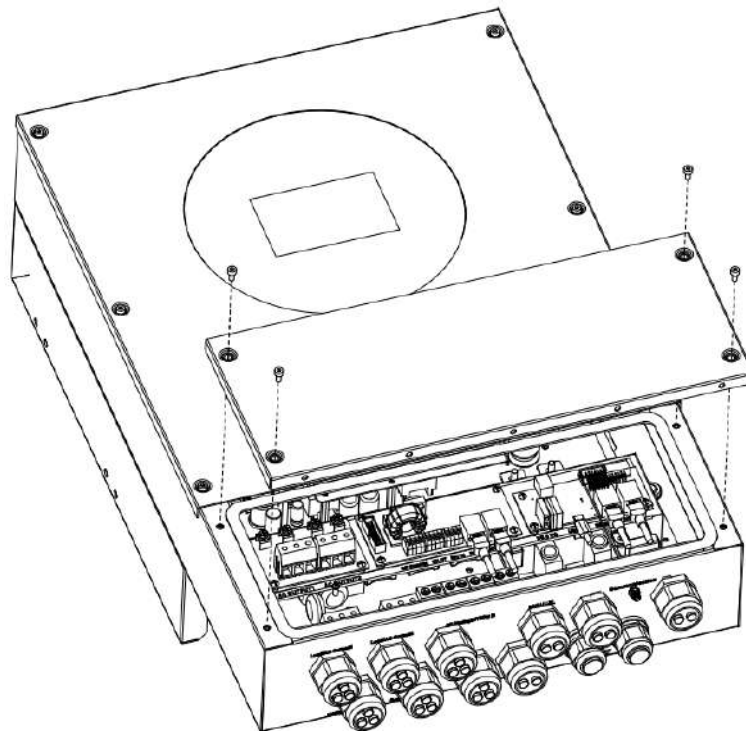

Installing the Unit

Preparation

This hybrid inverter is designed for indoor or outdoor use (IP66), please make sure the installation site meets below conditions:

- Not in direct sunlight
- Not in areas where highly flammable materials are stored.
- Not in potential explosive areas.
- Not in the cool air directly.

- Not near the television Antenna or antenna cable.
- Not higher than altitude of about 2000 meters above sea level.
- Please AVOID direct sunlight, rain exposure, snow laying up during installation and operation.

Select the Mounting Place

- Please select a vertical wall with load-bearing capacity for installation, appropriate for installation on concrete or other non-flammable surfaces.
- The ambient temperature should be between $-25\sim 60^{\circ}\text{C}$ to ensure optimal operation.
- Be sure to keep other objects and surfaces as shown in the diagram to guarantee sufficient heat dissipation and have enough space for removing wires.
- For proper air ventilation and heat dissipation, allow approximately 50 cm of clearance on each side of the unit and approximately 50 cm above and below it, and maintain at least 100 cm of clearance in front.
- The inverter should be installed in a shaded, rain proof or protected location.

Mounting the Unit

WARNING!! Remember that this inverter is heavy! Please be careful when lifting out from the package.

Installation to the wall should be implemented with the proper screws. After that, the device should be bolted on securely.

The inverter only can be used in a CLOSED ELECTRICAL OPERATING AREA. Only service person can enter this area.

WARNING!! FIRE HAZARD.
SUITABLE FOR MOUNTING ON CONCRETE OR OTHER NON-COMBUSTIBLE SURFACE ONLY.

Step 1: Fix two brackets on the two sides of the inverter with 8 screws.

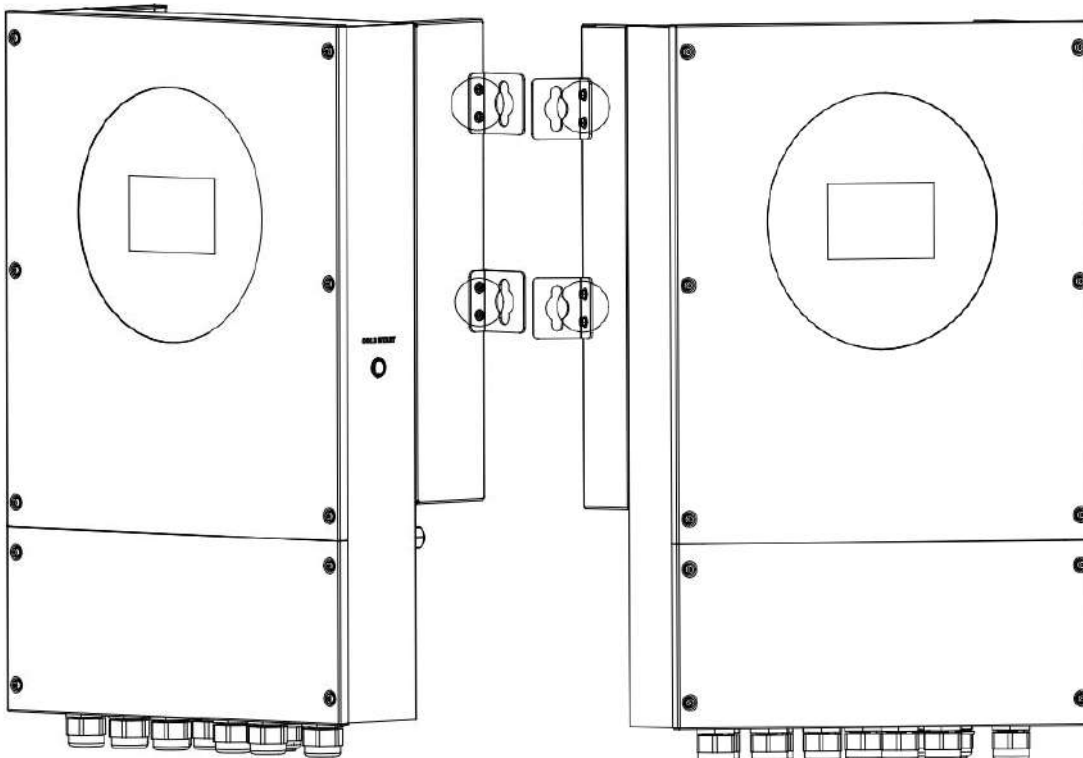

Step 2: Install the inverter by screwing two screws on the top of two brackets.

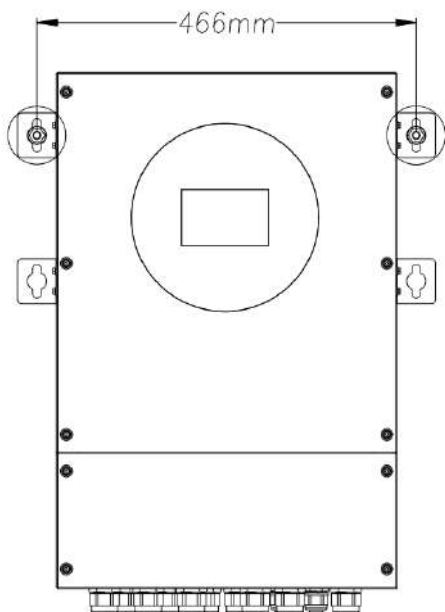

Step 3: Then, fix the remaining two mounting holes with screws.

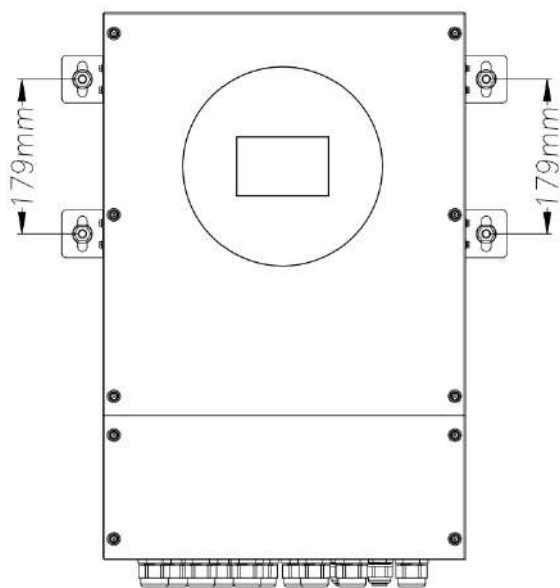

Step 4: The inverter should be installed in a shaded, rain proof or protected location.

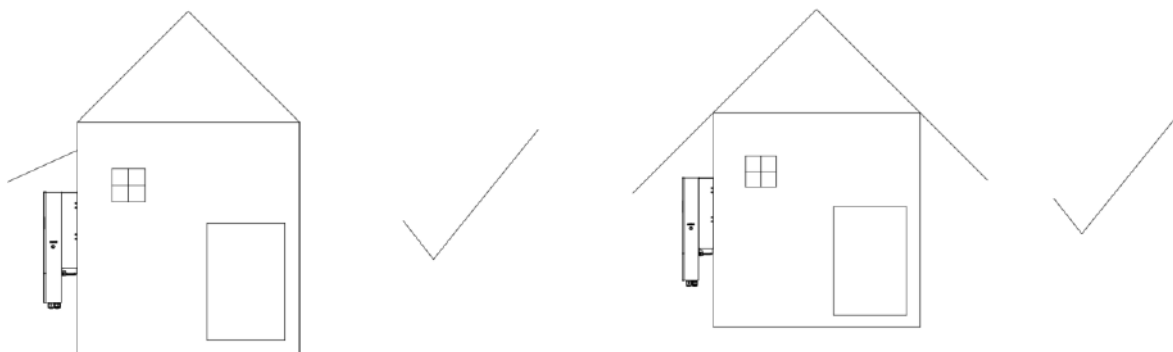

Battery Connection

CAUTION: For safety operation and regulation compliance, it's requested to install a separate DC over-current protector or disconnect device between battery and inverter. It may not be requested to have a disconnect device in some applications, however, it's still requested to have over-current protection installed. Please refer to typical amperage in below table as required fuse or breaker size.

WARNING! All wiring must be performed by qualified personnel.

WARNING! It's very important for system safety and efficient operation to use appropriate cable for battery connection. To reduce risk of injury, please use the proper recommended cable and terminal size as below.

Recommended battery cable and terminal size:

MODEL	Typical Amperage	Wire Size	Torque Value
6KW	125A	1*2AWG	1.98 Nm

For 6KW model:

Please follow the below steps to implement battery connection:

1. Remove insulation sleeve 18~19mm for two conductors.
2. Insert battery wires according to polarities indicated on the terminal block and tighten the terminal screws.
Make sure polarity at both the battery and the inverter/charge is correctly connected.

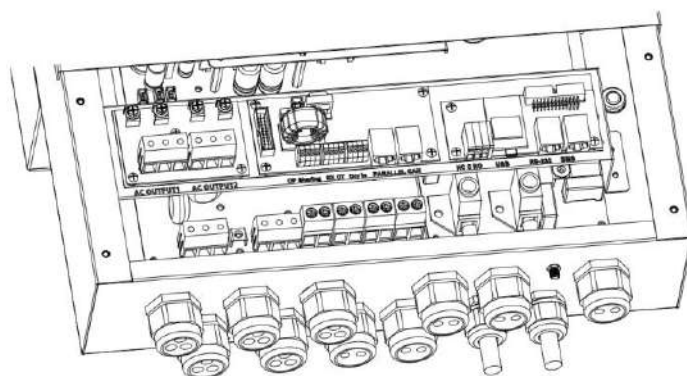
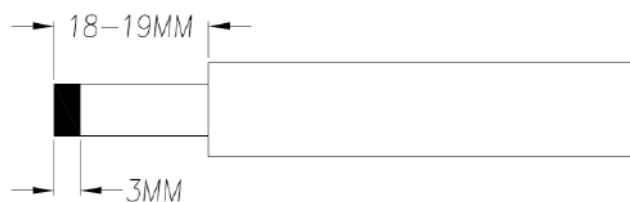

6KW



WARNING: Shock Hazard

Installation must be performed with care due to high battery voltage in series.



CAUTION!! Do not place anything between the flat part of the inverter terminal and the ring terminal. Otherwise, overheating may occur.

CAUTION!! Do not apply anti-oxidant substance on the terminals before terminals are connected tightly.

CAUTION!! Before making the final DC connection or closing DC breaker/disconnector, be sure positive (+) must be connected to positive (+) and negative (-) must be connected to negative (-).

AC Input/Output Connection

CAUTION!! Before connecting to AC input power source, please install a **separate** AC breaker between inverter and AC input power source. The recommended spec of AC breaker is 50A. This will ensure the inverter can be securely disconnected during maintenance and fully protected from over current of AC input.

CAUTION!! There are two terminal blocks with "IN" and "OUT" markings. Please do NOT mis-connect input and output connectors.

WARNING! All wiring must be performed by a qualified personnel.

WARNING! It's very important for system safety and efficient operation to use appropriate cable for AC input connection. To reduce risk of injury, please use the proper recommended cable size as below.

Suggested cable requirement for AC wires

MODEL	Gauge	Torque Value
6KW	10 AWG	1.2~ 1.6 Nm

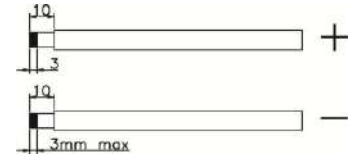

Please follow below steps to implement AC input/output connection:

1. Before making AC input/output connection, be sure to open DC protector or disconnecter first.
2. Remove insulation sleeve 10-11mm.
3. Insert AC input wires according to polarities indicated on terminal block and tighten the terminal screws. Be sure to connect PE protective conductor (⊕) first.

⊕ → **Ground (yellow-green)**

L → **LINE (brown or black)**

N → **Neutral (blue)**

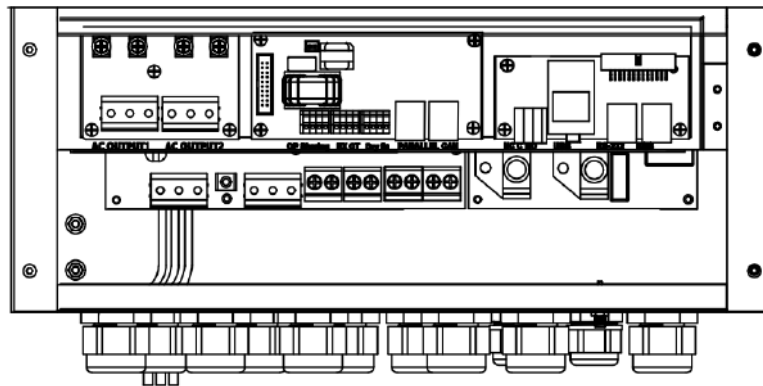

Utility AC INPUT

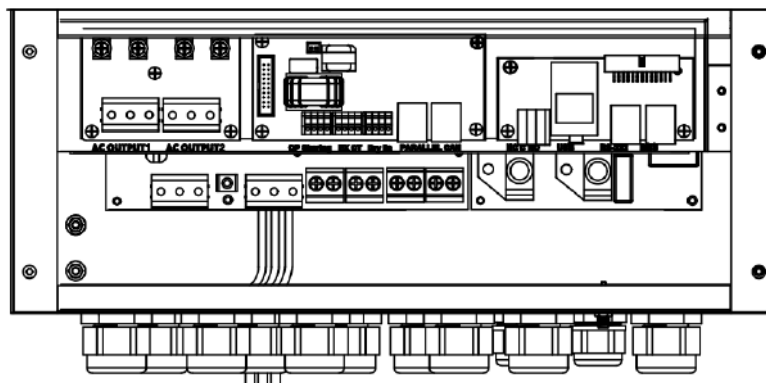

Generator AC INPUT



WARNING:

Be sure that AC power source is disconnected before attempting to hardwire it to the unit.

4. This inverter is equipped with dual-output. There are two outputs: AC output 1 and AC output 2. It's set up through LCD program or monitoring software to turn on and off the second output. Refer to "LCD setting" section for the details.
 Insert AC output wires according to polarities indicated on terminal block and tighten terminal screws. Be sure to connect PE protective conductor (⊕) first.

⊕ → **Ground (yellow-green)**
L → **LINE (brown or black)**
N → **Neutral (blue)**

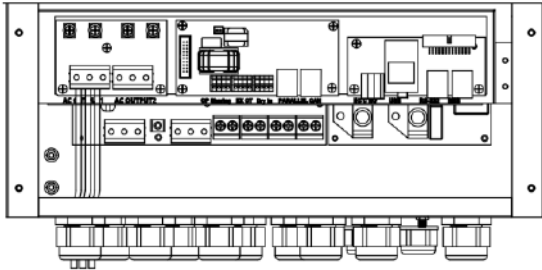

AC Output 1

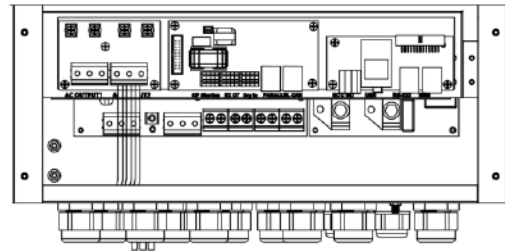

AC Output 2

5. Make sure the wires are securely connected.

CAUTION: Important

Be sure to connect AC wires with correct polarity. If L and N wires are connected reversely, it may cause utility short-circuited when these inverters are worked in parallel operation.

CAUTION: Appliances such as air conditioner are required at least 2~3 minutes to restart because it's required to have enough time to balance refrigerant gas inside of circuits. If a power shortage occurs and recovers in a short time, it will cause damage to your connected appliances. To prevent this kind of damage, please check manufacturer of air conditioner if it's equipped with time-delay function before installation. Otherwise, this inverter/charger will trig overload fault and cut off output to protect your appliance but sometimes it still causes internal damage to the air conditioner.

The working logic of the generator

The generator is mainly used to substitute the Utility power to ensure the normal operation of the inverter. There are two operation situations:

- (1) Connect to the generator and Utility when the Utility is normal:
 The inverter will close the Grid relay, and at this time, the utility will provide power to load, charge battery or feed the grid. In this case, the generator relay will be open.
- (2) Connect to the generator when the Utility is abnormal or lost:
 The inverter will close the generator relay, and at this time, the generator will provide power to load. The generator does not charge the battery by default, and if it needs to be charged, it needs to enable the Generator Charging Setting. In this case, the grid relay will be open.

NOTE 1: After the generator is connected, the inverter will automatically turn off the grid-connected function to protect the generator.

NOTE 2: Only when the inverter is set to single-machine mode, the generator will be connected.

PV Connection

CAUTION: Before connecting to PV modules, please install **separately** a DC circuit breaker between inverter and PV modules.

WARNING! All wiring must be performed by a qualified personnel.

WARNING: Please switch off the inverter before you connect PV modules. Otherwise, it will damage the inverter.

WARNING! It's very important for system safety and efficient operation to use appropriate cable for PV module connection. To reduce risk of injury, please use the proper recommended cable size as below.

MODEL	Typical Amperage	Cable Size	Torque
6KW	21A	14AWG	2.0~2.4Nm

PV Module Selection:

When selecting proper PV modules, please be sure to consider below parameters:

1. Open circuit Voltage (Voc) of PV modules not exceeds max. PV array open circuit voltage of inverter.
2. Open circuit Voltage (Voc) of PV modules should be higher than min. battery voltage.

Solar Charging Mode	
Max. PV Array Open Circuit Voltage	500 Vdc
PV Array MPPT Voltage Range	120~450Vdc
MPP Number	2

Please follow below steps to implement PV module connection:

1. Remove insulation sleeve 10-11 mm for positive and negative conductors.
2. Check correct polarity of connection cable from PV modules and PV input connectors. Then, connect positive pole (+) of connection cable to positive pole (+) of PV input connector. Connect negative pole (-) of connection cable to negative pole (-) of PV input connector.

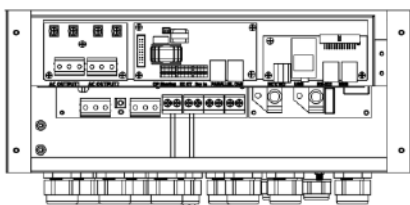
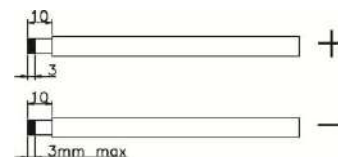

Solar 1

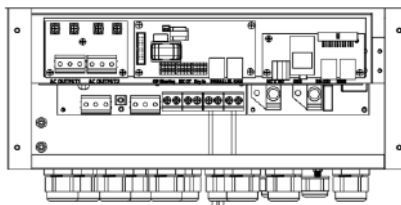

Solar 2

Recommended PV Module Configuration

Solar Panel Spec				
Nominal Max. power (Pmax)(W)	450	454	615	620
Opt. Operating Voltage (Vmp) (V)	41.4	41.6	44.6	44.8
Opt. Operating Current (Imp) (A)	10.87	10.91	13.79	13.84
Open Circuit Voltage (Voc) (V)	48.9	49	52.4	52.6
Short Circuit Current (Isc) (A)	11.68	11.73	14.72	14.78
Solar Panel Configuration (For 6KW)				
Numbers in series of MPPT1	7	7	9	9
Numbers of strings in MPPT1	2	2	1	1
Maximum input voltage of MPPT1 (V)	342.3	343	471.6	473.4
Input power of MPPT1 (W)	6300	6356	5535	5580
Numbers in series of MPPT2	7	6	9	9
Numbers of strings in MPPT2	2	2	1	1
Maximum input voltage of MPPT1 (V)	342.3	294	471.6	473.4
Input power of MPPT2 (W)	6300	5448	5535	5580
Total input power (W)	12600	11804	11070	11160

Communication Connection

Please use the supplied communication cable to connect to the inverter and PC. Follow the below procedure to connect communication wiring. Insert bundled CD into a computer and follow the on-screen instructions to install the monitoring software. For the detailed software operation, please check the user manual of the software inside of a CD.

Serial Connection

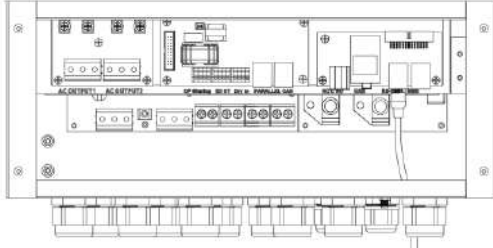
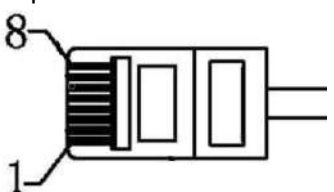
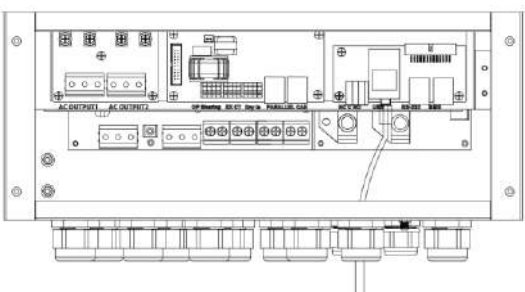
For RS232 port, you should use a RJ45 cable as follows:	For USB port, you should use a USB cable as follows:
PIN1: TXD, PIN2:RXD, PIN4:12V, PIN8:GND	
 <p>The RJ45 line sequence is as follows:</p> 	

BMS Communication

For BMS port, you should use a RJ45 cable as follows:

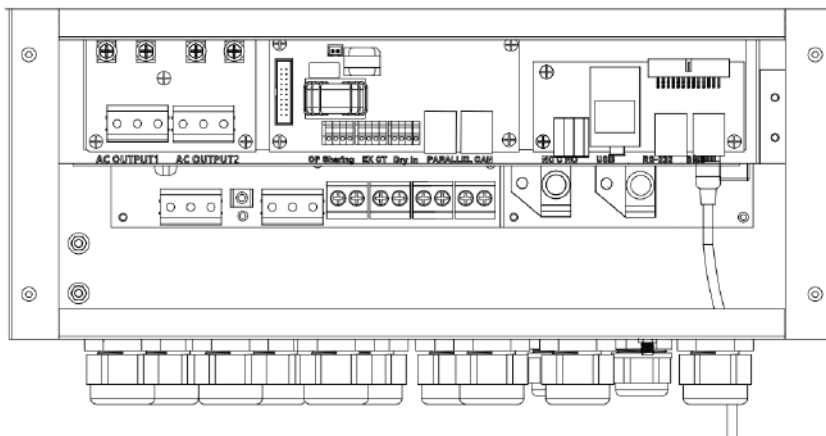

It is recommended to purchase a special communication cable if you are connecting to Lithium-ion battery. Please use a RJ45 cable to connect BMS communication port and PIN assignment is listed as below table:

PIN Assignment	
PIN 3	RS485-B
PIN 5	RS485-A
PIN 8	GND

For more information, please refer to Appendix II: BMS Communication Installation.

Dry Contact Signal

There is one dry contact (3A/250VAC) available on the rear panel. This dry contact is used to start or stop the generator, which can be set in the **Setting ->Generator Settings** on the HMI LCD.

NOTE: Be sure to enable Dry Contact Setting in LCD setting. Otherwise, the dry contact state is consistent with the power off state.

Unit Status	Condition		Dry contact port: 	
			NC & C	NO & C
Power Off	Unit is off and no output is powered.		Close	Open
Power On	Output is powered from Utility.(Utility available)		Close	Open
	Generator Settings→ Generator ON voltage/SOC	When Battery voltage /SOC < Generator ON voltage/SOC	Open	Close
	Generator Settings→ Generator OFF voltage/SOC	When Battery voltage /SOC > Generator OFF voltage/SOC	Close	Open

OPERATION

LCD Display Icons





The LCD is touchscreen. The main interface display screen is as follows:

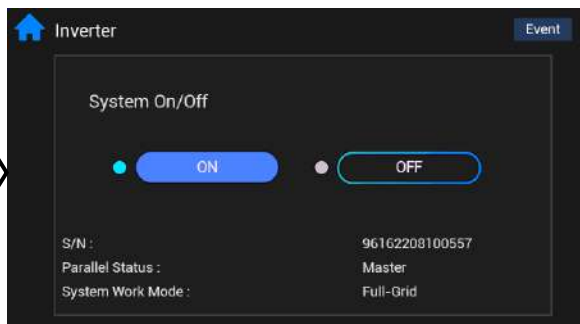

1. This top displays the time, WIFI status, BMS, and alarm sound.
2. System settings icon, press this setting button to enter the system settings screen including general setting, output setting, battery setting, advanced setting, grid setting, and generator setting.
3. The main screen show information including inverter solar, grid/ Generator, battery ,load. It also displays the direction of energy flow through arrows, clearly showing the working status of the inverter.
4. Touch "Press to ON" to enter the system turn on/off screen. This page can also display information such as inverter serial number, version number, event records, etc

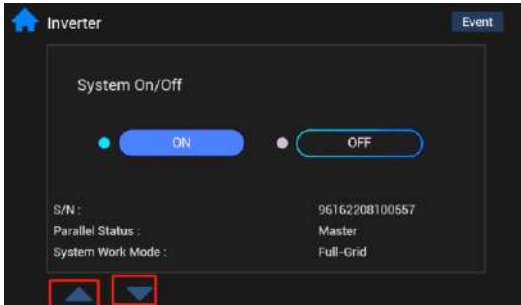

5. Press  key to Back to home screen.

Icon	Function description
System on/off, Fault information and Configuration procedures	
	<p>The top of the screen indicates the time of the local month, day and year.</p>
	<p>Touch the "ON" icon to enter another interface to control the switch of the inverter and query the software version and machine status (including the serial number, parallel status, operating mode, DSP version, MCU version, remote version, and LCD version, TP Version of the inverter).</p>
	<p>Touch "▲" or "▼" check the machine S/N number, parallel status, system working status, software version number.</p> <p>Touch "System On/Off" to control the inverter switch.</p>
	<p>Touch "Event" to view the alarms and error records.</p>

Grid&Generator Information

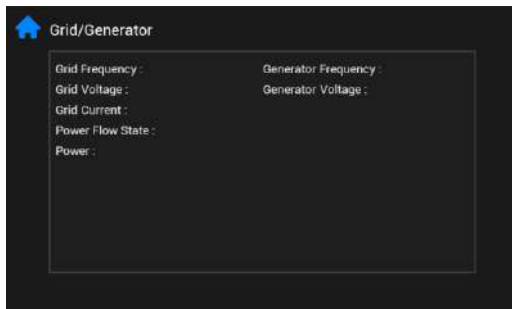

Grid/Generator icon:

Cycle display of AC input voltage (grid and generator), current, and power.

When you touch this icon, it display detailed grid and generator information. It includes grid frequency, voltage, current, power flow state ,power, Generator frequency and generator voltage.

Pv Information



Cycle display of the "PV1&PV2" voltage, current and power.

When you touch this icon, it display detailed PV information. It includes total PV power, PV1/PV2 voltage and current power, daily power generation, monthly power generation, annual power generation, total power generation will be displayed.

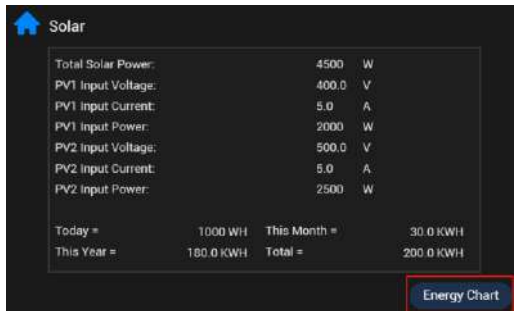

When you touch the "Energy Chart" you will enter the "Solar Power Flow page"

Solar power curve for daily, monthly, yearly and total can be checked on the LCD, we can also view more detailed power generation through the monitoring system.

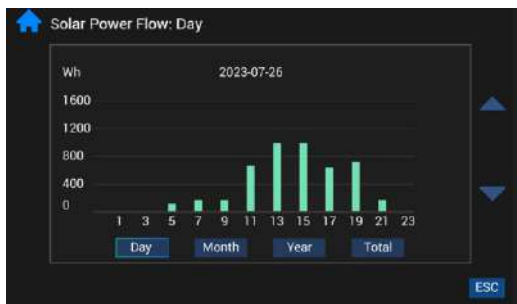

Press "ESC" icon to back to previous page.

Battery Information



Cycle display the "Battery" voltage (SOC) ,current and power.

Battery detail page

1. This page indicates the battery Type, statue, SOC, voltage, current and power.
2. If you use lithium battery, you can press "BMS Information" to check lithium battery information.

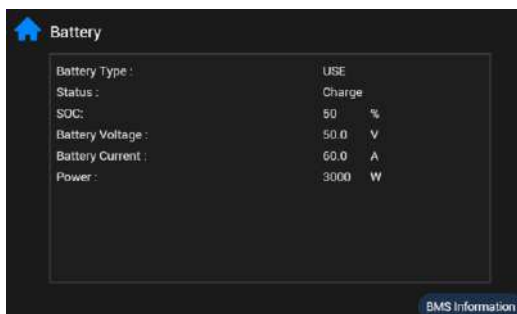

When you touch "BMS Information" it will display the communication status, maximum charge voltage, maximum discharge current, cut-off voltage point, maximum discharge current point.

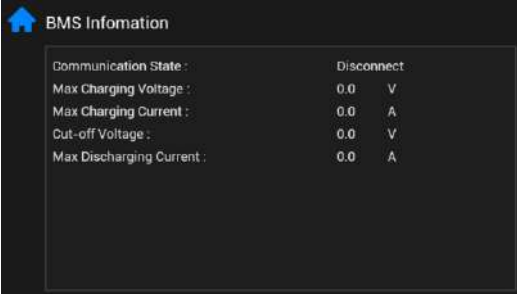

Load Information



Cycle display the output 1 & 2 voltage, power and output current.

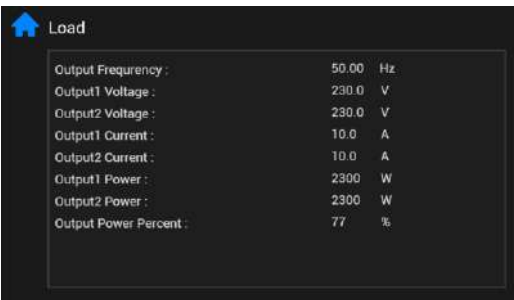

When you touch this icon, it will display the "OP1/OP2" frequency, battery current, power, and output percentage.

LCD Setting



System settings icon, press this setting button to enter the system settings screen Including general setting, output setting, batter setting , system operation Mode setting , Grid setting. See "LCD Setting" section for the details.

Operation Status Information



The red marked sections can respectively display the BMS, buzzer, and wifi status.



The red marked display sections indicate the measurement mode: "V" for voltage value, "I" for current value, and "P" for power value.



LCD Setting

The red marked section is for entering the settings interface, which includes **general setting, output setting, battery setting, advanced setting, grid setting, generator setting**

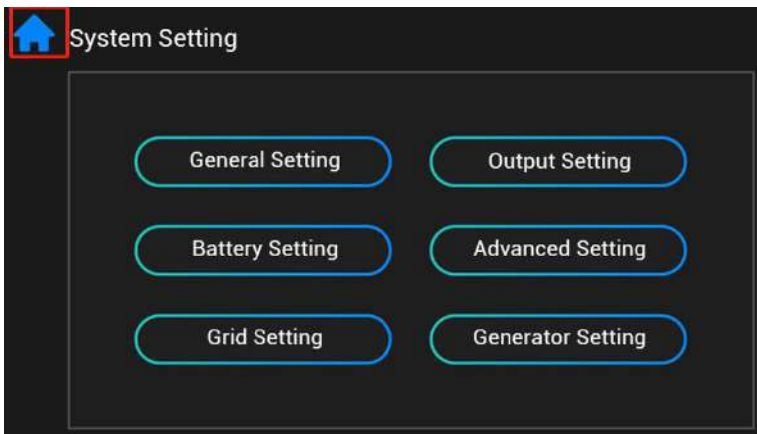

Press  key to Back to home screen.

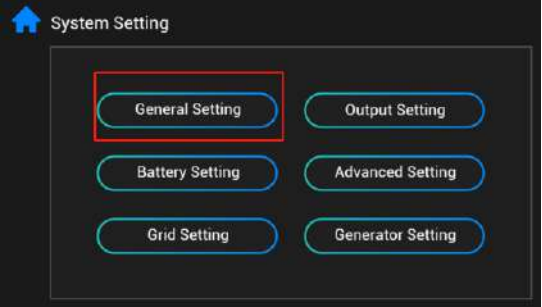

Program Description	Function description
General Setting	
	<p>This is General Setting detail page</p> <p>Time Setting: Set system time.</p> <p>LCD Sleep Time: LCD sleep time can be set always/30 seconds/ 1 minute /never.</p> <p>Alarm control: Can set enable or disable alarms.</p> <p>Overload Bypass: Can set enable or disable bypass overload</p> <p>Touch "ESC" to return to the previous screen, and touch "" to return to the home screen</p>

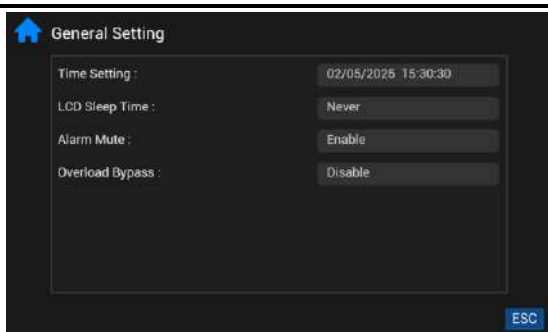

Output Setting

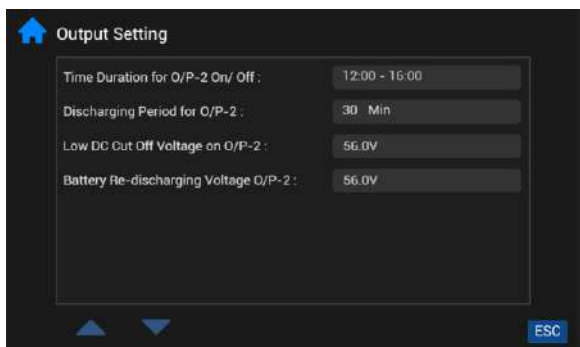
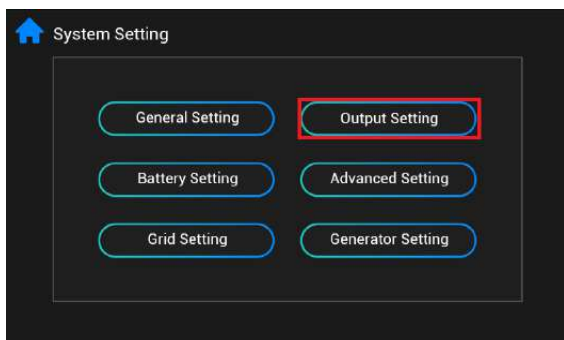

This is Output Setting detail page.

Output voltage: The output Voltage can be set 220/ 230/ 240 V

Output frequency: The frequency can be set 50/ 60 Hz

AC Output mode: You can modify this parameter to set it to single mode or parallel mode. For more details please see "AC Output mode" setting section.

Output source priority: You can modify "SUB" or "SBU".

Time Duration for Total AC Output On/off: You can control the output1/2 Working time.

Time Duration for O/P-2 On/Off: You can control the start and end time of Output 2

Discharging Period for O/P-2: You can control the output2 Working time.

Low DC Cut Off Voltage on O/P-2: Turn off the OP output when the battery voltage is below the set point.

Battery Re-discharging Voltage O/P-2: Turn off the OP output when the battery voltage is higher than the set point.

Touch "ESC" to return to the previous screen, and touch "" to return to the home screen

Battery Setting

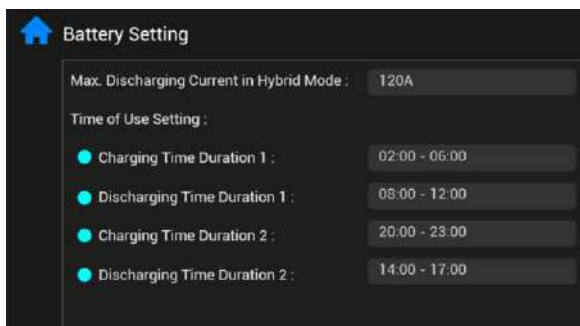
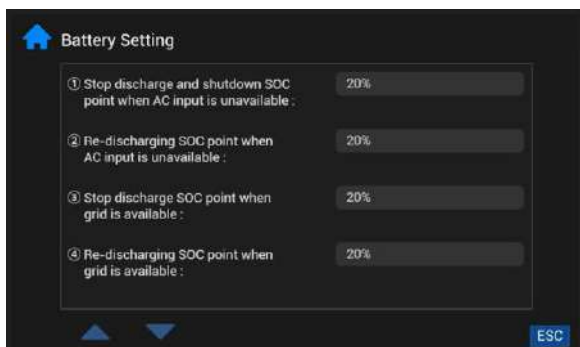
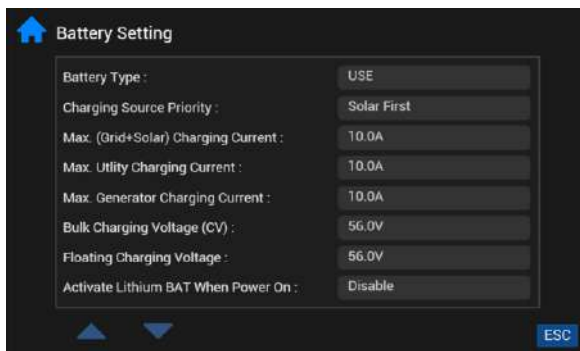
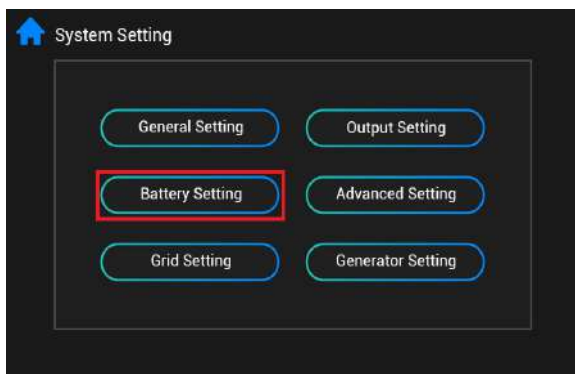

This is Battery Setting detail page

Battery type: "Use" means lead-acid battery, while others are lithium battery protocols.

Charging Source Priority: It includes both regular **settings** and **scheduled settings**

Regular: Solar first , solar and Utility, Only solar

Schedule: You can customize the charging time period.

Max(Grid+ Solar) Charging Current: setting range is from 10A to the maximum charging current. Increment of each click is 10A.

Max. Utility Charging Current: setting range is from 2A to the maximum charging current. Increment of each click is 10A.

Max. Discharging Current: You can set the maximum discharge current of the battery

CV Voltage: Setting range is from 48.0V to 60.0V. If the battery type is lithium battery, this parameter follows its BMS voltage parameter.

Floating Voltage: Setting range is from 48.0V to 60.0V. If the battery type is lithium battery, this parameter follows its BMS voltage parameter.

Activate Lithium BAT when Power on: Enabling this option will activate the lithium battery.

Battery low cut off and Re-discharging setting :

① ② ③ ④

You can customize battery low cut off voltage/SOC and Re-discharging voltage/SOC.

Max Discharging Current in hybrid Mode: When enabling the battery feed to grid function, this setting can set the maximum battery discharge current.

Time Of Use Setting:

It's to set up battery charging and discharging time periods.

Solar Priority: PV energy distribution priority

Touch "ESC" to return to the previous screen, and touch "" to return to the home screen.

Advanced Setting

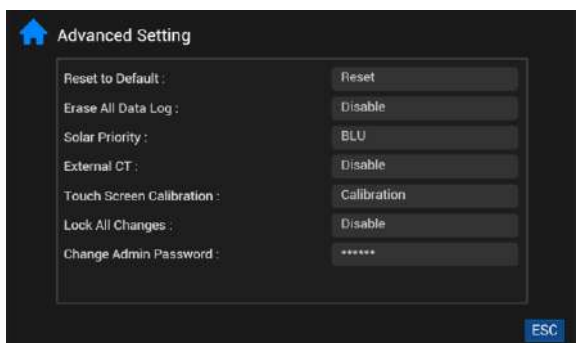
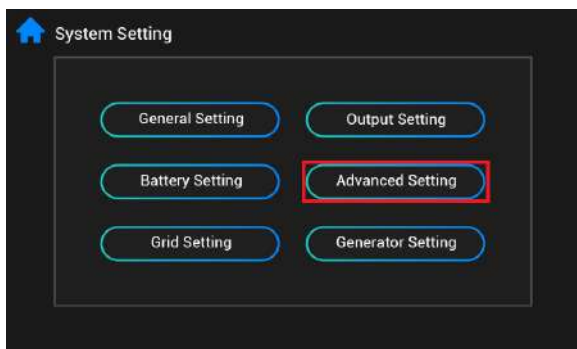

Advanced Setting

It is required a password to enter. The default password is 0000, but you can also change it in "Change Admin Password".

Reset to Default: If this option is enabled, the machine will go back to factory Settings.

Erase All Data log: Clear all energy generation data

Solar Priority: Set the priority of PV energy

External CT: If Zero Export To CT function is required, you need to enable this setting item, which default setting is "disable".

Touch Screen Calibration: You can calibrate the touch screen sensitivity.

Lock All Changes: If enabled is selected, key settings are locked and cannot be modified.

Change Admin Password: You can change the password to access Advanced Setting page.

Grid Setting

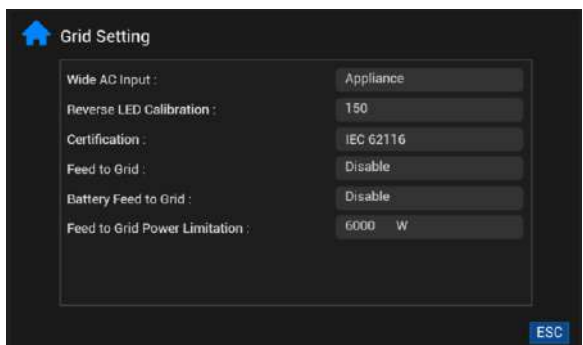
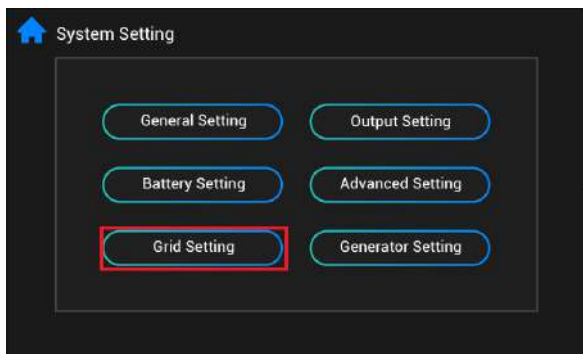

This is Grid Setting detail page

Wide AC Input:

If APL selected, acceptable AC input voltage range will be within 90-280VAC.

If UPS selected, acceptable AC input voltage range will be within 170-280VAC.

Reverse LED Calibration: This will adjust the Grid power.

Certification: It only shows IEC62116. It's not allowed to change.

Feed to Grid: If enable is selected, solar energy is allowed to feed to the grid.

Battery Feed to Grid: If enable is selected, battery energy is allowed to feed to the grid.

Feed to Grid Power Limitation: Set limitation to feed to the grid. The available options are 6600W, 8600W and 10600W.

Generator Setting

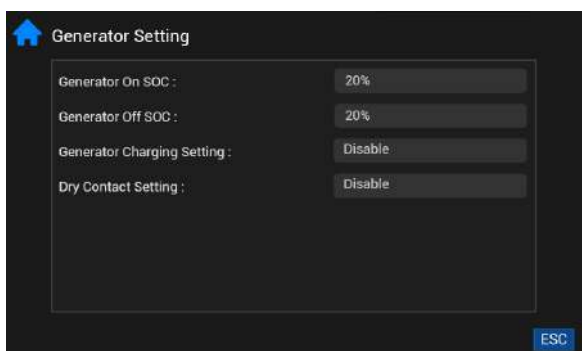
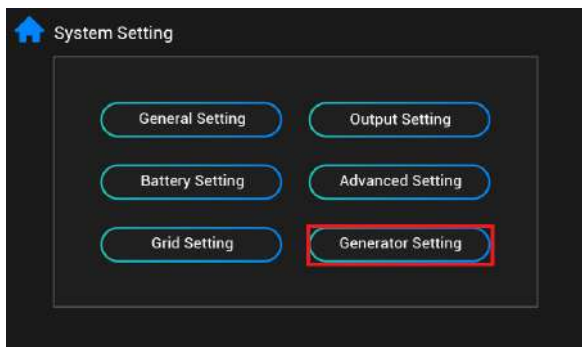

This is Generator Setting detail

Generator On Voltage: When the battery voltage/SOC is lower than this voltage, the dry contact will activate and start the generator.

Generator Off Voltage: When the battery voltage/SOC is higher than this voltage, the dry contact will activate and start the generator.

Generator Charging Setting: Enable this setup item generator to charge the battery

Dry Contact Setting:

- **Disable:** The dry contact state is consistent with the Power Off state: **NC&C: Close NO&C: Open**, not controlled by battery SOC.
- **Enable:** The dry contact state depends on the setting conditions of the generator ON voltage/SOC.

Please refer to "Dry Contact Signal" section for the details. Touch "ESC" to return to the previous screen, and touch "" to return to the home screen.

Operating Mode Description

We can check the system status according to "System Work Mode", as shown below:



System work mode	Behaviors	State description
Standby mode Note: *Standby mode: The inverter is not turned on yet but at this time, the inverter can charge battery without AC output.	No output power, solar or utility charger available	Battery is charged by PV energy.
		No charging.
Line mode	Output power from utility. Charger is available	Utility charges battery and provides power to load.
		PV energy, battery power and utility provide power to load.
		PV energy and utility charge battery, and utility provides power to load.
		PV energy charges battery, utility and PV energy provide power to the load.
Battery mode	Output power from battery or PV	PV energy and battery energy supply power to the load.
		PV energy charges battery and provides power to the load.
		Battery provides power to the load.
Only PV mode	Output power from PV	PV provides power to the load.
Fault mode Note: *Fault mode: Errors are caused by inside circuit error or external reasons such as over temperature, output short circuited and so on.	No output, no charging.	No charging.

Warning/Fault Event

we can check the Warning code and Fault event according to "Event", as shown below:

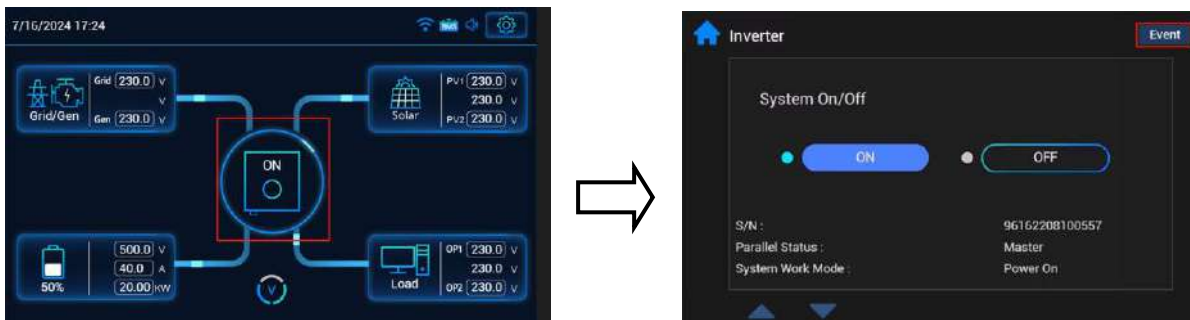

Warning Indicator

Warning Code	Warning Event
01	Fan is locked
02	Over temperature
03	Battery over charged
04	Low battery
07	Overload
10	Inverter power derating
32	Communication lost between com. port and control board

Faults Reference Code

Fault Code	Fault Event
01	Fan is locked.
02	Over temperature
03	Battery voltage is too high.
05	Output is short circuited.
06	Output voltage is abnormal.
07	Overload time out.
08	Bus voltage is too high.
09	Bus soft start failure.
10	PV current is over.
11	PV voltage is over.
12	Charge current is over.
13	Battery Power Low
19	Battery Overcurrent
21	Phase error in three phases system
51	Over current or surge
52	Bus voltage is too low.
53	Inverter soft start failure.
55	Over DC offset in AC output
57	Current sensor failure.
58	Output voltage is too low.

SPECIFICATIONS

MODEL	6KW	8.6KW	10.6KW
RATED OUTPUT POWER	6600W	8600W	10600W
PV INPUT (DC)			
Max. PV Power	12000W	16000W	18000W
Max. PV Array Open Circuit Voltage	500 VDC	500 VDC	500 VDC
MPPT Range @ Operating Voltage	120 VDC~450 VDC	120 VDC~450 VDC	120 VDC~450 VDC
Max. PV Array Maximum Imp/per MPPT	2*21A	2*27A	2*27A
Max. PV Array Maximum Isc/per MPPT	26.25	2*34A	2*34A
Number of MPPT Tracker	2	2	2
GRID-TIE OPERATION			
GRID OUTPUT (AC)			
Nominal Output Voltage	220/230/240 VAC		
Feed-in Grid Voltage Range	195.5~253 VAC @India regulation 184 ~ 264.5 VAC @Germany regulation 184 ~ 264.5 VAC @South America regulation 195.5~253 VAC @ South Africa 182~260 VAC @ Pakistan		
Feed-in Grid Frequency Range	49~51Hz @India regulation 47.5~51.5Hz @Germany regulation 57~62Hz @South America 47~52Hz @ South Africa 45.1~54.9Hz @ Pakistan		
Nominal Output Current	28.7A	37.4A	46.1A
Power Factor Range	>0.99		
Maximum Conversion Efficiency (DC/AC)	97%		
OFF-GRID, HYBRID OPERATION			
GRID INPUT			
Acceptable Input Voltage Range	90 - 300 VAC or 170 - 300 VAC		
Frequency Range	50 Hz/60 Hz (Auto sensing)		
Transfer Time	< 10ms (for UPS) < 20ms (for home appliances) < 50ms (for parallel system operation)		
Rating of AC Transfer Relay	40A	60A	60A
GENERATOR INPUT			
Acceptable Input Voltage Range	90 - 300 VAC	90 - 300 VAC	90 - 300 VAC
Frequency Range	50 Hz/60 Hz (Auto sensing)	50 Hz/60 Hz (Auto sensing)	50 Hz/60 Hz (Auto sensing)
Rating of AC Transfer Relay	40A	60A	60A
BATTERY MODE OUTPUT (AC)			
Nominal Output Voltage	220/230/240 VAC		
Output Waveform	Pure Sine Wave		
Efficiency (DC to AC)	93%		
BATTERY & CHARGER			
Nominal DC Voltage	48 VDC		
Maximum Charging Current (from Grid)	135A	190A	210A
Maximum Charging Current (from PV)	135A	190A	210A
Maximum discharging Current	135A	190A	210A
GENERAL			
Dimension, D X W X H (mm)	633 x 418 x 192		
Net Weight (kgs)	23.5	28	29
INTERFACE			
Parallel-able	Yes		
External Safety Box (Optional)	Yes		
Communication	USB or RS232 / RS 485/WIFI		
ENVIRONMENT			
Humidity	0 ~ 95% RH (No condensing)		
Operating Temperature	-25°C to 50°C		

TROUBLE SHOOTING

Problem	HMI/Buzzer	Explanation / Possible cause	What to do
Unit shuts down automatically during startup process.	HMI and buzzer will be active for 3 seconds and then complete off.	The battery voltage is too low (<1.91V/Cell)	1. Re-charge battery. 2. Replace battery.
No response after power on.	No indication.	1. The battery voltage is far too low. (<1.4V/Cell) 2. Battery polarity is connected reversed.	1. Check if batteries and the wiring are connected well. 2. Re-charge battery. 3. Replace battery.
Mains exist but the unit works in battery mode.	HMI shows grid voltage is 0V	Input protector is tripped	Check if AC breaker is tripped and AC wiring is connected well.
When the unit is turned on, internal relay is switched on and off repeatedly.	HMI shows battery voltage is 0V	Battery is disconnected.	Check if battery wires are connected well.
Buzzer beeps continuously and HMI show the Fault icon	Overload error	The inverter is overload 110% and time is up.	Reduce the connected load by switching off some equipment.
	Output short circuited.	Output short circuited.	Check if wiring is connected well and remove abnormal load.
	Over Temperature	Internal temperature of inverter component is over 100°C.	Check whether the air flow of the unit is blocked or whether the ambient temperature is too high.
	Battery high voltage	Battery is over-charged.	Return to repair center.
		The battery voltage is too high.	Check if spec and quantity of batteries are meet requirements.
	FAN lock	Fan fault	Replace the fan.
	Output abnormal	Output abnormal (Inverter voltage below than 190Vac or is higher than 260Vac)	1. Reduce the connected load. 2. Return to repair center
	DC-DC overcurrent	DC/DC over current or surge.	Restart the unit, if the error happens again, please return to repair center.
	Inverter overcurrent	Over current or surge.	
	BUS low voltage	Bus voltage is too low.	
	Abnormal output voltage	Output voltage is unbalanced.	
	Solar high voltage	Solar input voltage is more than 550V.	Solar input voltage is more than 550V.
	Battery Low	The battery voltage is less than 30V	The battery voltage is less than 30V
Battery overcurrent	The battery is over-discharged	The discharge current of the battery needs to be reduced	

Appendix I: Parallel function

1. Introduction

This inverter can be used in parallel with two different operation modes.

1. Parallel operation in single phase with up to 9 units.
2. Maximum nine units work together to support three-phase equipment. Seven units support one phase maximum.

2. Mounting the Unit

When installing multiple units, please follow below chart.

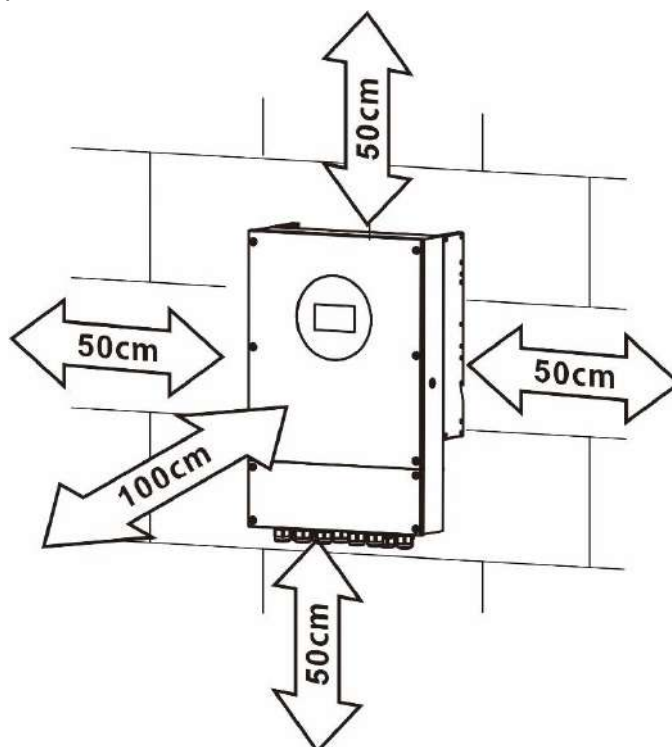

NOTE: For proper air ventilation and heat dissipation, allow approximately 50 cm of clearance on each side of the unit and approximately 50 cm above and below it, and maintain at least 100 cm of clearance in front.

Wiring Connection

NOTICE: It's requested to connect to battery for parallel operation.

The cable size of each inverter is shown as below:

Recommended battery cable and terminal size for each inverter:

MODEL	AWG no.	Torque
6KW	1*2AWG	2~3 Nm

WARNING: Be sure the length of all battery cables is the same. Otherwise, there will be voltage difference between inverter and battery to cause parallel inverters not working.

Recommended AC input and output cable size for each inverter:

MODEL	AWG no.	Torque
6KW	10 AWG	1.2~1.6Nm

You need to connect the cables of each inverter together. Take the battery cables for example: You need to use a connector or bus-bar as a joint to connect the battery cables together, and then connect to the battery terminal. The cable size used from joint to battery should be X times cable size in the tables above. "X" indicates the number of inverters connected in parallel.

Regarding AC input and output, please also follow the same principle.

WARNING!! Make sure all output N wires of each inverter must be connected all the time. Otherwise, it will cause inverter fault in error code #72.

CAUTION!! Please install the breaker at the battery and AC input side. This will ensure the inverter can be securely disconnected during maintenance and fully protected from over current of battery or AC input. The recommended mounted location of the breakers is shown in the figures in 5-1 and 5-2.

Recommended breaker specification of battery for each inverter:

Model	1 unit*
6KW	140A/70VDC

*If you want to use only one breaker at the battery side for the whole system, the rating of the breaker should be X times current of 1 unit. "X" indicates the number of inverters connected in parallel.

Recommended breaker specification of AC input with single phase:

Model	2 units	3 units	4 units	5 units	6 units	7 units	8 units	9 units
6KW	80A/ 230VAC	120A/ 230VAC	160A/ 230VAC	200A/ 230VAC	240A/ 230VAC	280A/ 230VAC	320A/ 230VAC	360A/ 230VAC

Note1: Also, you can use one unit of 50A and install one breaker at its AC input in each inverter.

Note2: Regarding three-phase system, you can use 4-pole breaker directly and the rating of the breaker should be compatible with the phase current limitation from the phase with maximum units

Recommended battery capacity

Inverter parallel numbers	2	3	4	5	6	7	8	9
Battery Capacity	400AH	600AH	800AH	1000AH	1200AH	1400AH	1600AH	1800AH

WARNING! Be sure that all inverters will share the same battery bank. Otherwise, the inverters will transfer to fault mode.

3-1. Parallel Operation in Single phase

Two inverters in parallel:

Power Connection

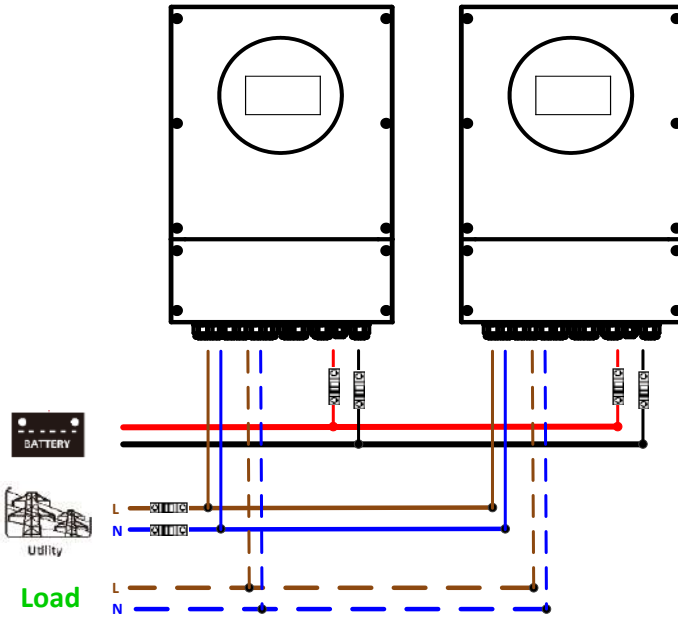

Communication Connection

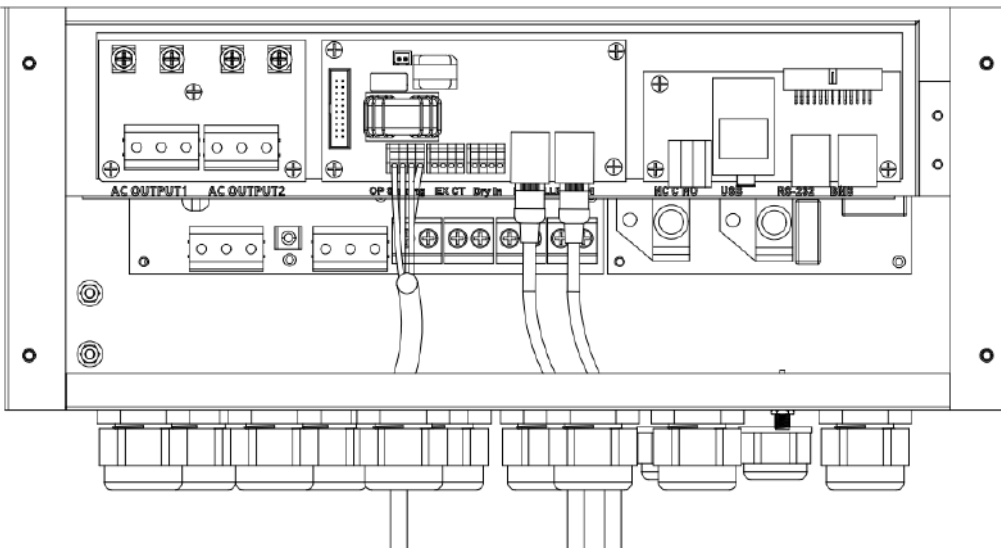

Three inverters in parallel:

Power Connection

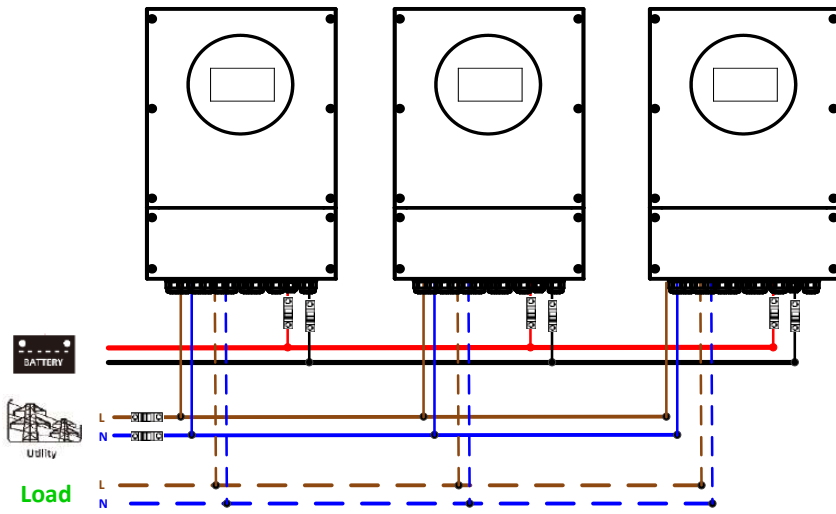

Communication Connection

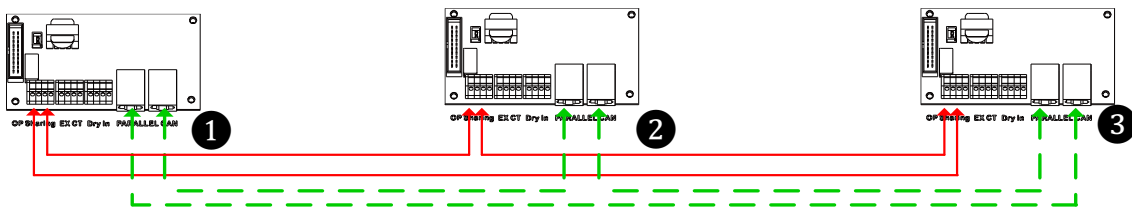

Four inverters in parallel:

Power Connection

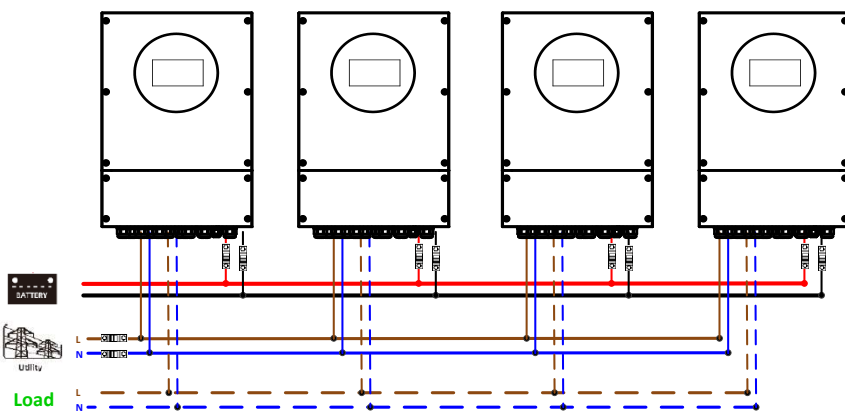

Communication Connection

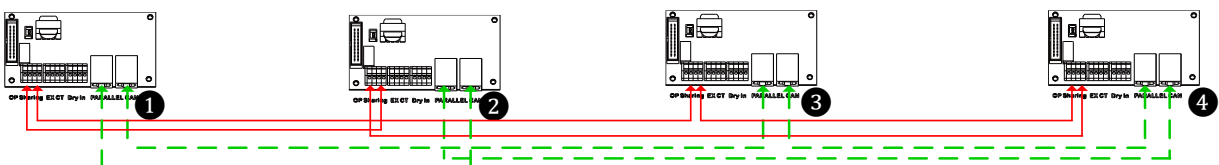

Five inverters in parallel:

Power Connection

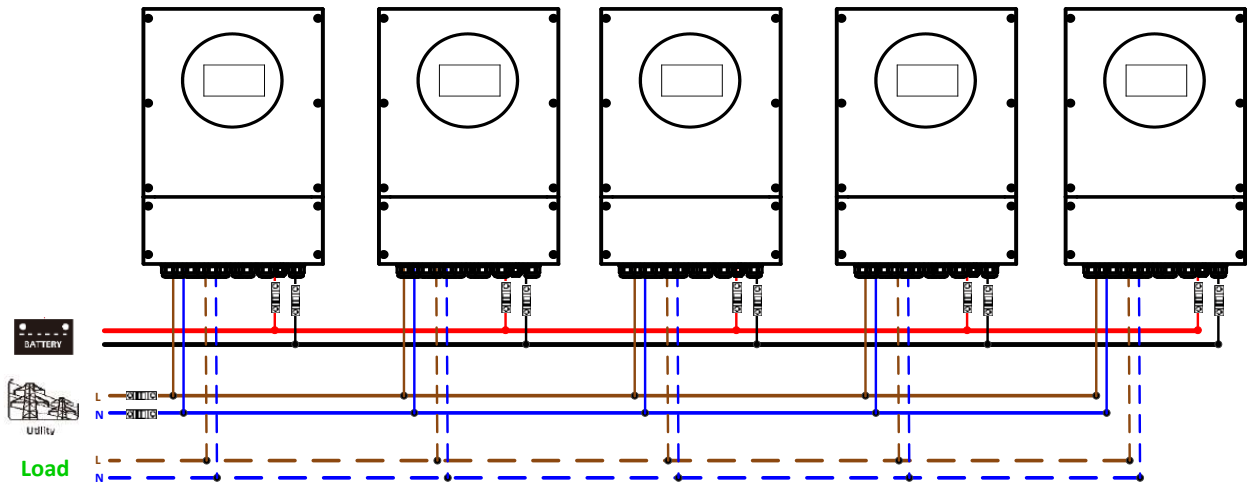

Communication Connection

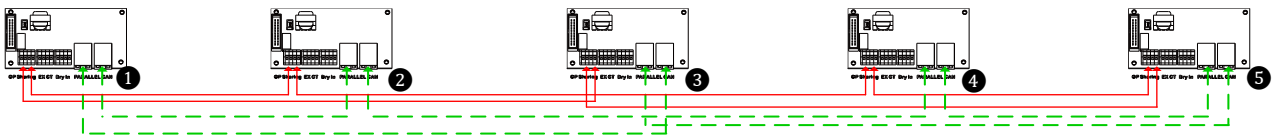

Six inverters in parallel:

Power Connection

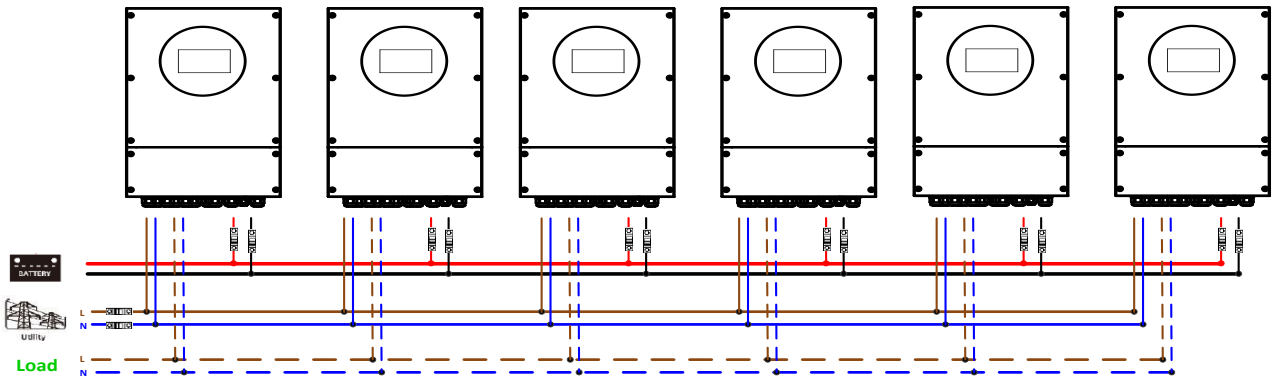

Communication Connection

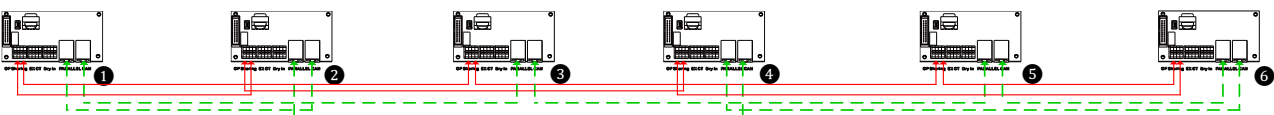

Seven to nine inverters in parallel:

Power Connection

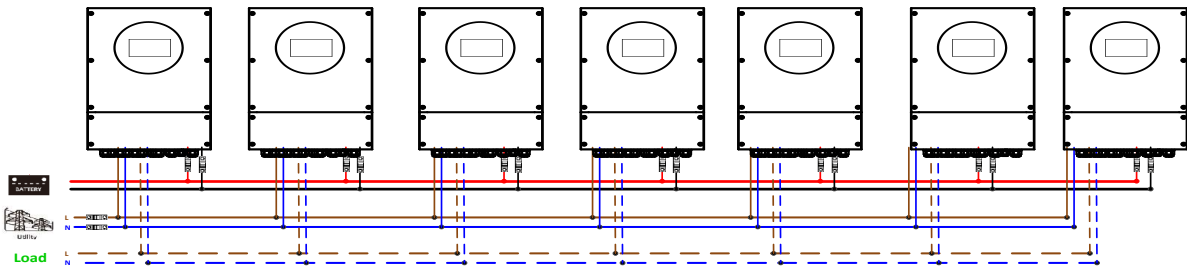

WARNING: When the number of parallel machines exceeds 6 PCS, add a magnetic ring to the output L cable. The magnetic ring is placed in the accessory bag of the inverter.

Communication Connection

➤ Seven inverters in parallel

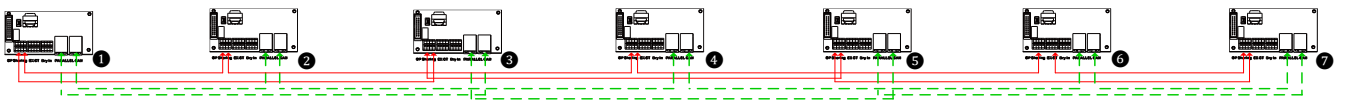

➤ Eight inverters in parallel

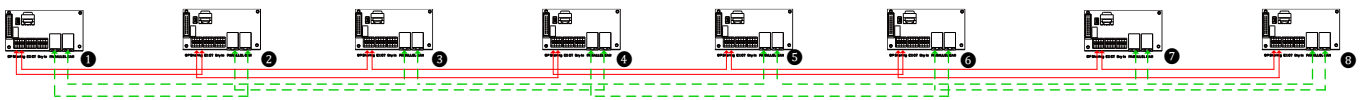

➤ Nine inverters in parallel

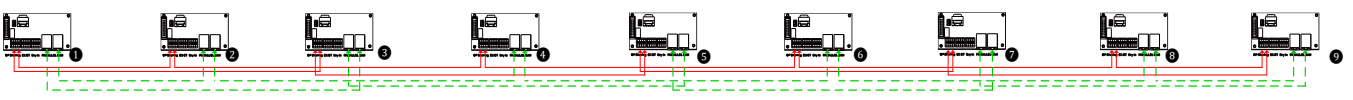

3-2. Support 3-phase equipment

Three inverters in each phase:

Power Connection

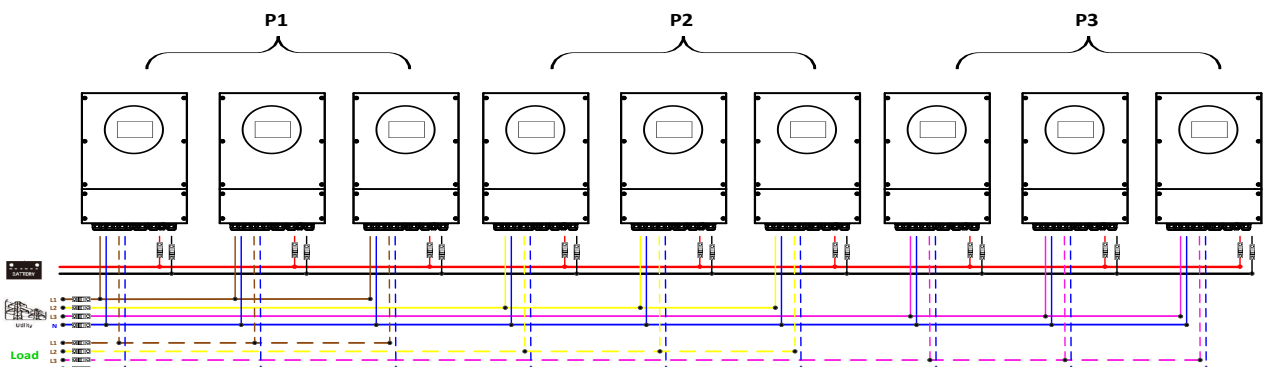

Communication Connection

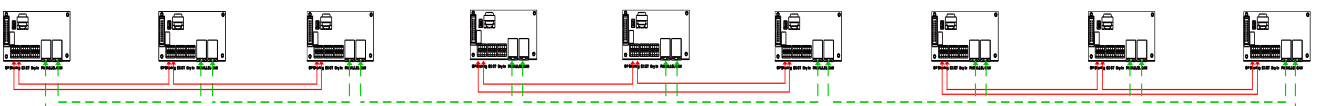

Three inverters in one phase, three inverters in second phase and two inverter for the third phase:

Power Connection

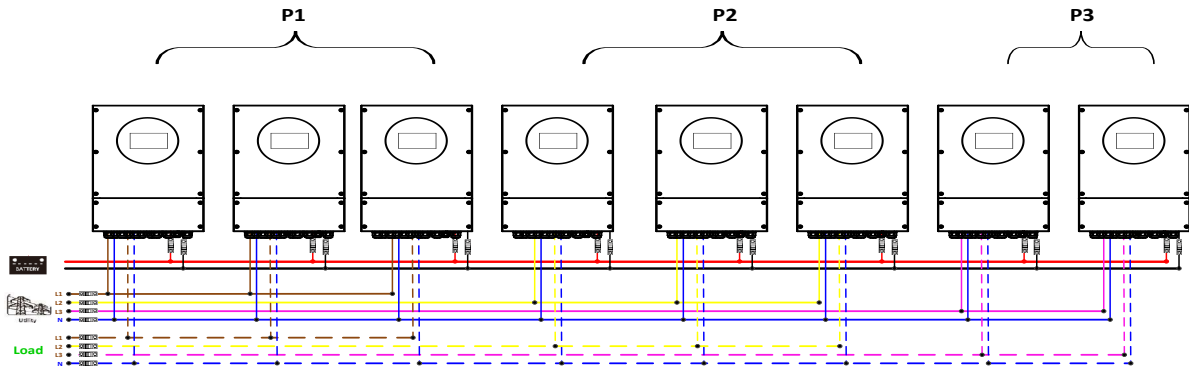

Communication Connection

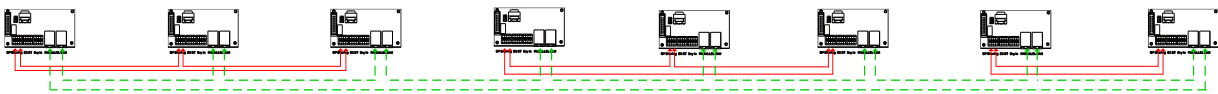

Three inverters in one phase, two inverters in second phase and two inverters for the third phase:

Power Connection

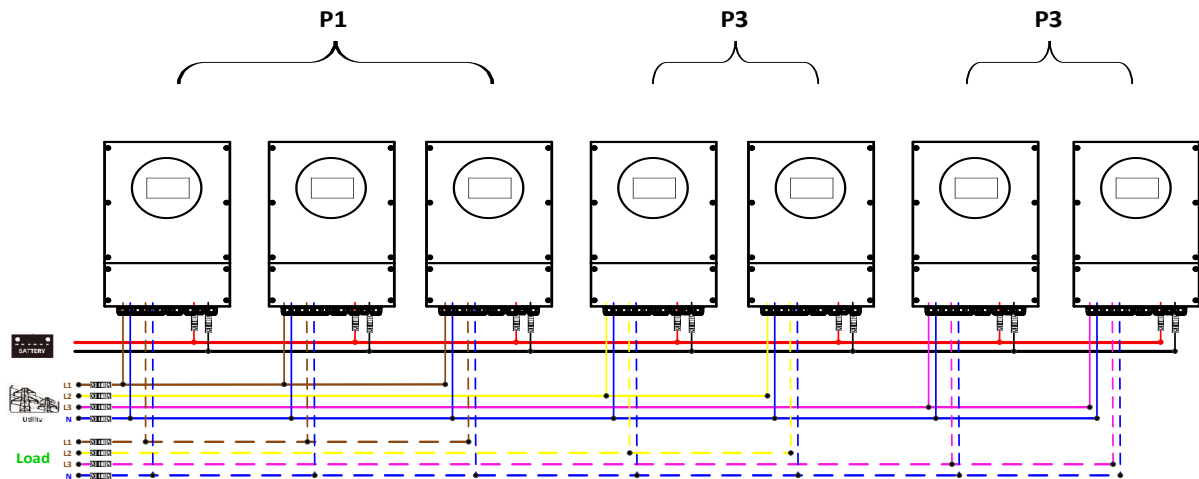

Communication Connection

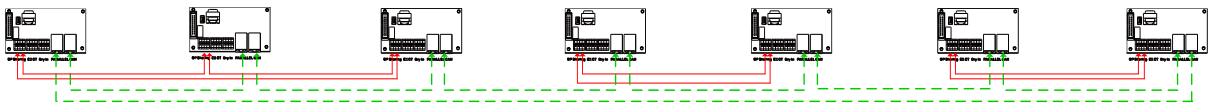

Two inverters in each phase:

Power Connection

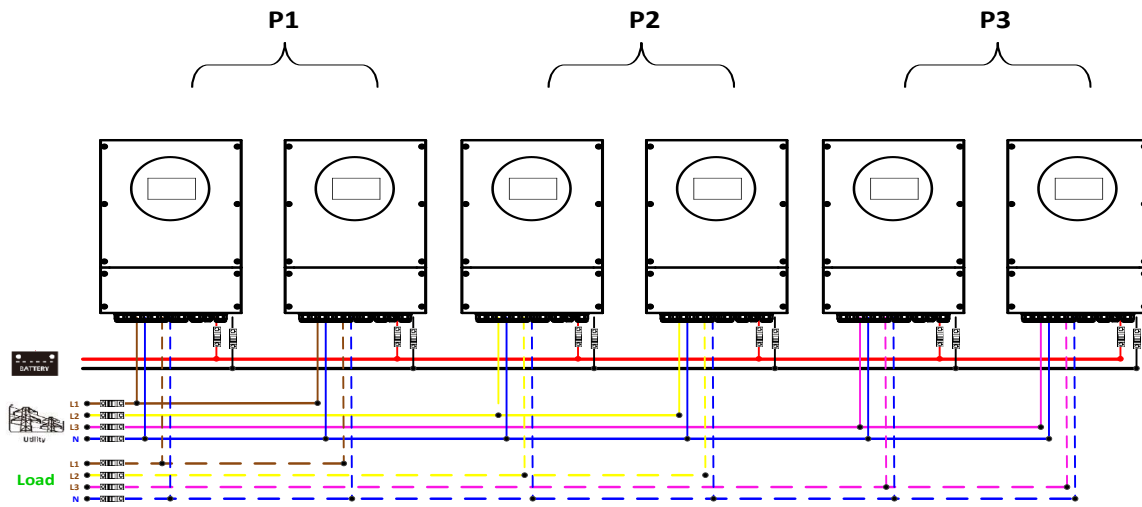

Communication Connection



Four inverters in one phase and one inverter for the other two phases:

Power Connection

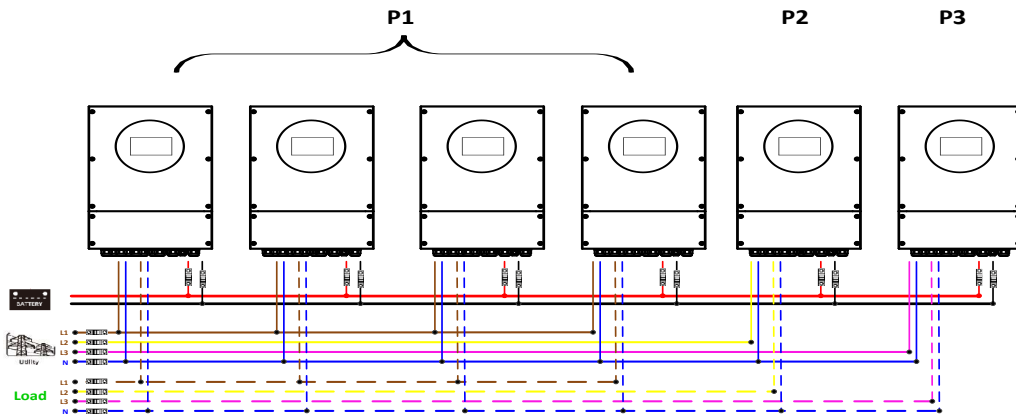

Communication Connection



Three inverters in one phase, two inverters in second phase and one inverter for the third phase:

Power Connection

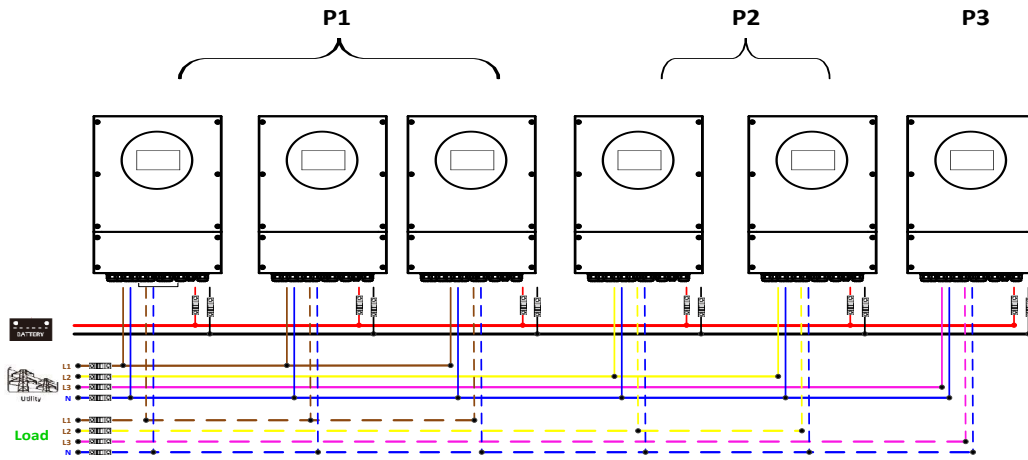

Communication Connection



Three inverters in one phase and only one inverter for the remaining two phases:

Power Connection

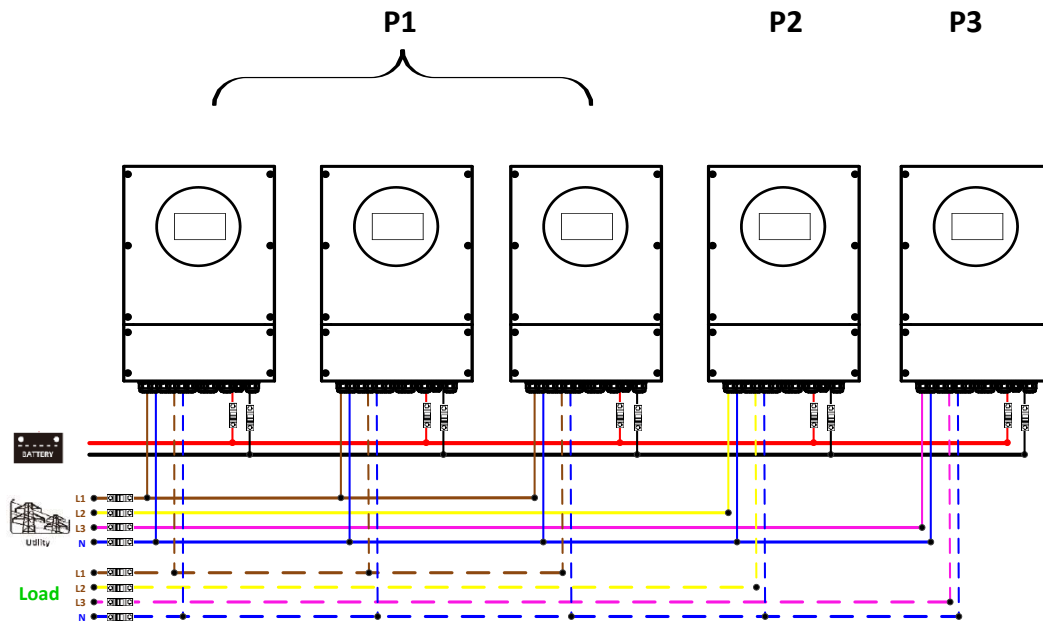

Communication Connection

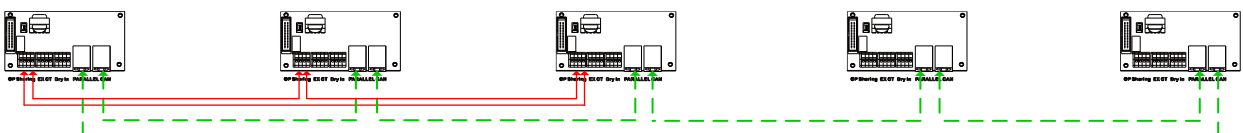

Two inverters in two phases and only one inverter for the remaining phase:

Power Connection

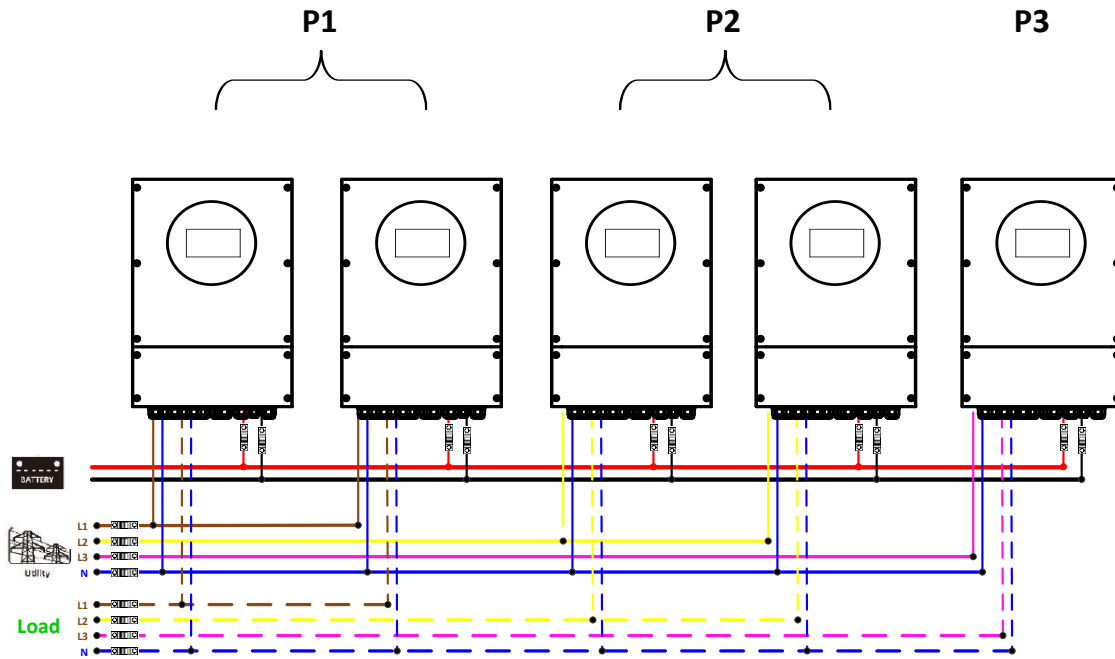

Communication Connection

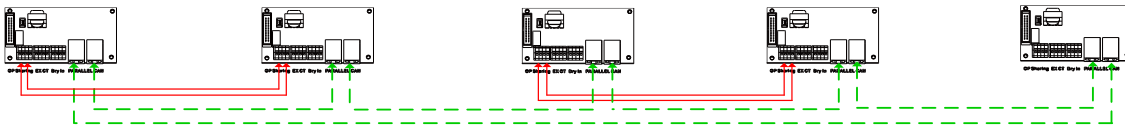

Two inverters in one phase and only one inverter for the remaining phases:

Power Connection

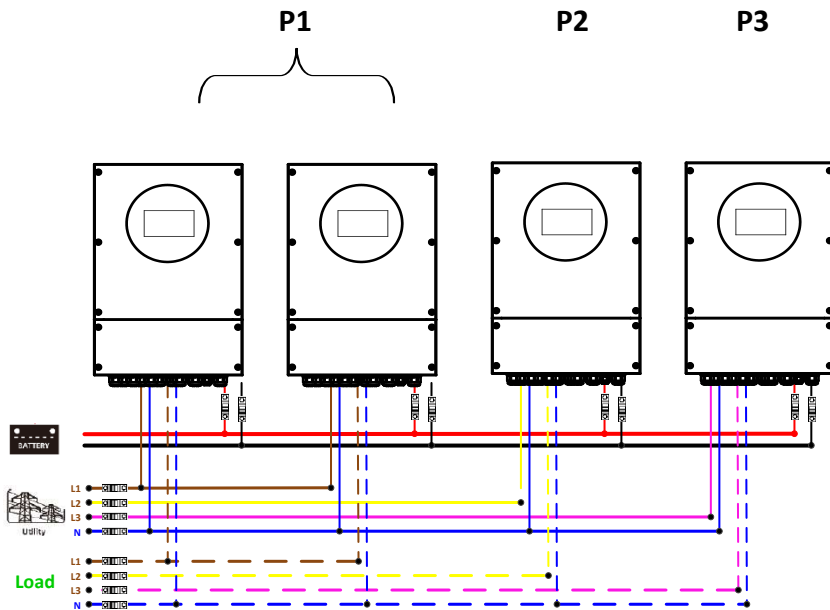

Communication Connection



One inverter in each phase:

Power Connection

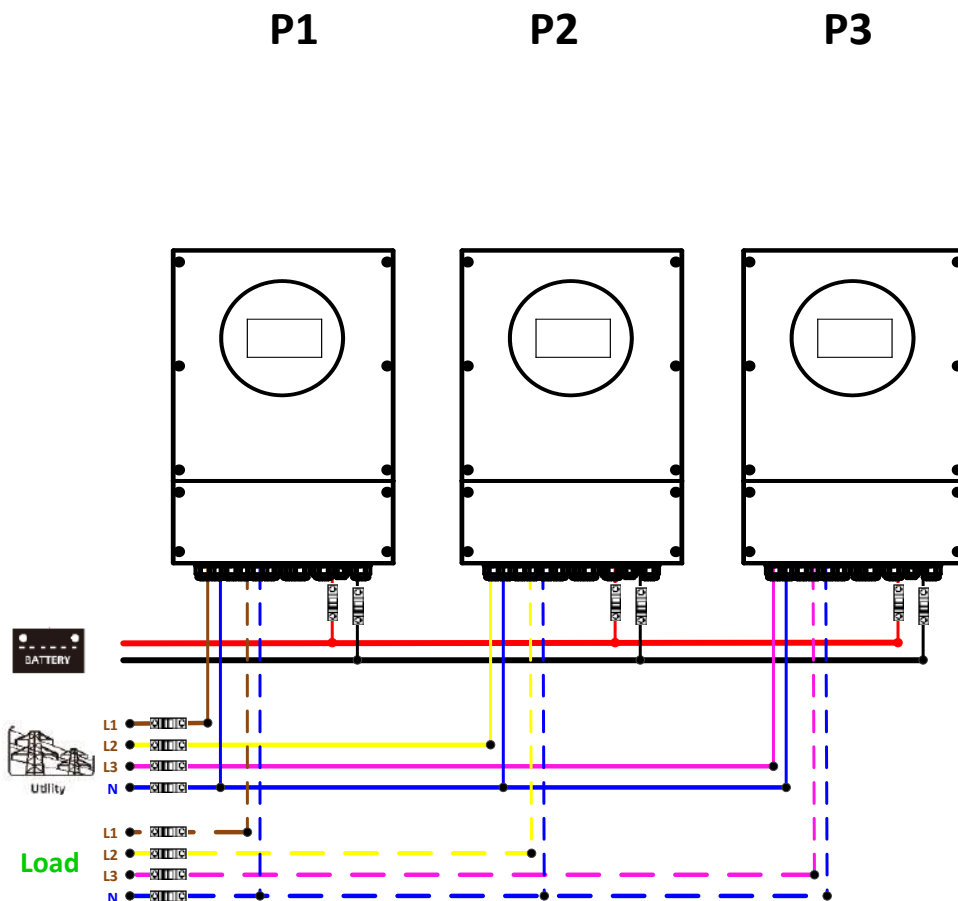

Communication Connection

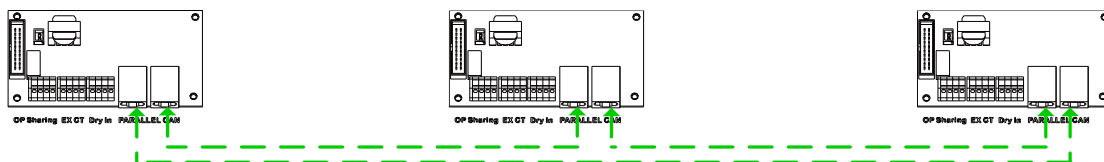

WARNING: Do not connect the current sharing cable between the inverters which are in different phases. Otherwise, it may damage the inverters.

4. PV Connection

Please refer to user manual of single unit for PV Connection.

CAUTION: Each inverter should connect to PV modules separately.

6. LCD Setting and Display

Parallel mode can be set according to the steps.

Setting-->Output setting→AC Output mode

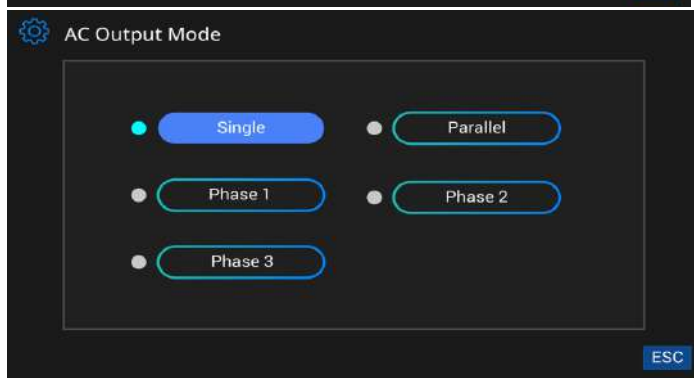
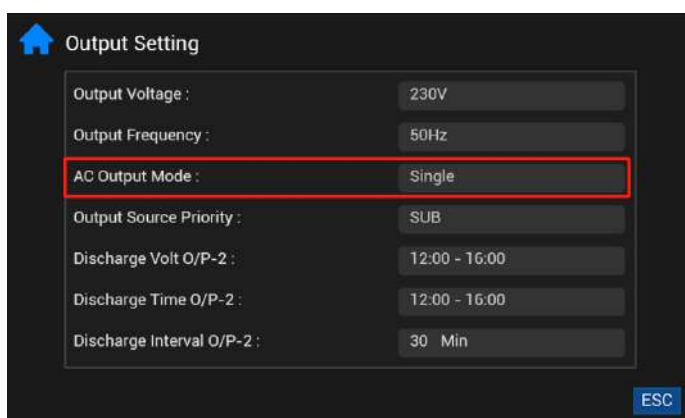
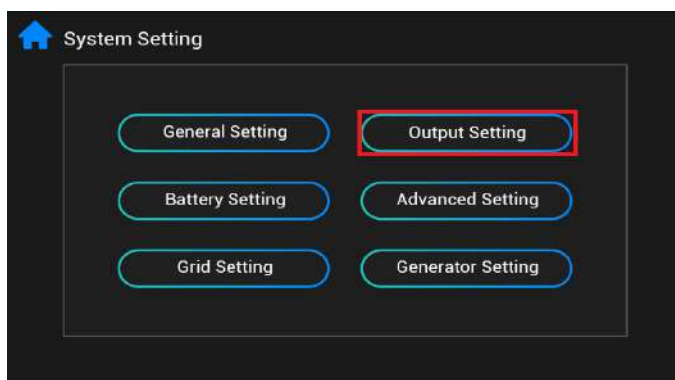

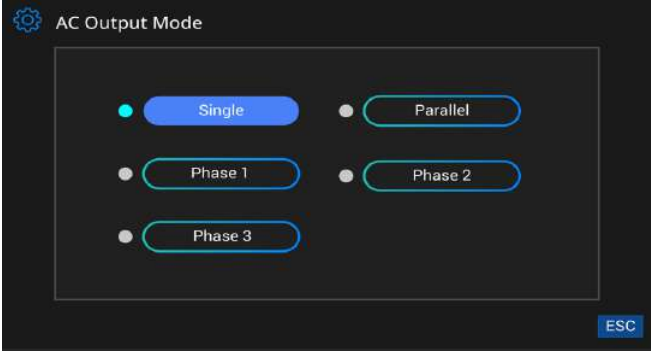
Program	Description	Selectable option		
Output Setting	AC output mode *This setting is only available when the inverter is in standby mode (Switch off).			
		Single:	When the units are used in parallel with single phase, please select "Parallel" in program Output Setting AC output mode.	
		Parallel:	It is required to have at least 3 inverters or maximum 9 inverters to support three-phase equipment. It's required to have at least one inverter in each phase or it's up to four inverters in one phase. Please refers to 5-2 for detailed information.	
		Phase 1:	Please select "Phase1" in program AC output mode for the inverters connected to L1 phase,	
		Phase 2:	"phase2" in program AC output mode for the inverters connected to L2 phase and	
		Phase 3:	"Phase3" in program AC output mode for the inverters connected to L3 phase.	
<p>Be sure to connect share current cable to units which are on the same phase. Do NOT connect share current cable between units on different phases. Besides, power saving function will be automatically disabled.</p>				

Code Reference:

Parallel Status	Code	Description
Single	Single	Un-identified unit for master or slave
Parallel	Master	Master unit
	Slave	Slave unit
Set of three phases	Phase 1	As a three-phase electric chess player L1 phase
	Phase 2	As a three-phase electric chess player L2 phase
	Phase 3	As a three-phase electric chess player L3 phase

Query the status in the figure below

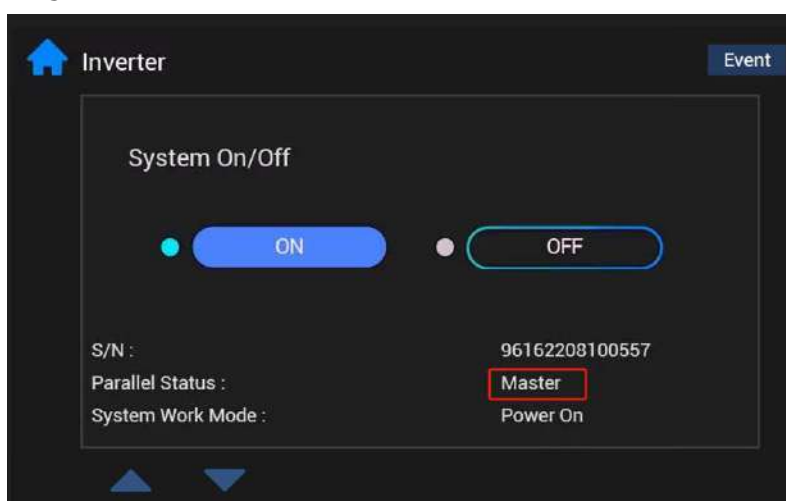

Commissioning

Parallel in single phase

Step 1: Check the following requirements before commissioning:

- Correct wire connection
- Ensure all breakers in Line wires of load side are open and each Neutral wires of each unit are connected together.

Step 2: Turn on each unit and set "Parallel" in LCD setting Output Setting of each unit. And then shut down all units.

NOET: It's necessary to turn off switch when setting LCD program. Otherwise, the setting can not be programmed.

Step 3: Turn on each unit.

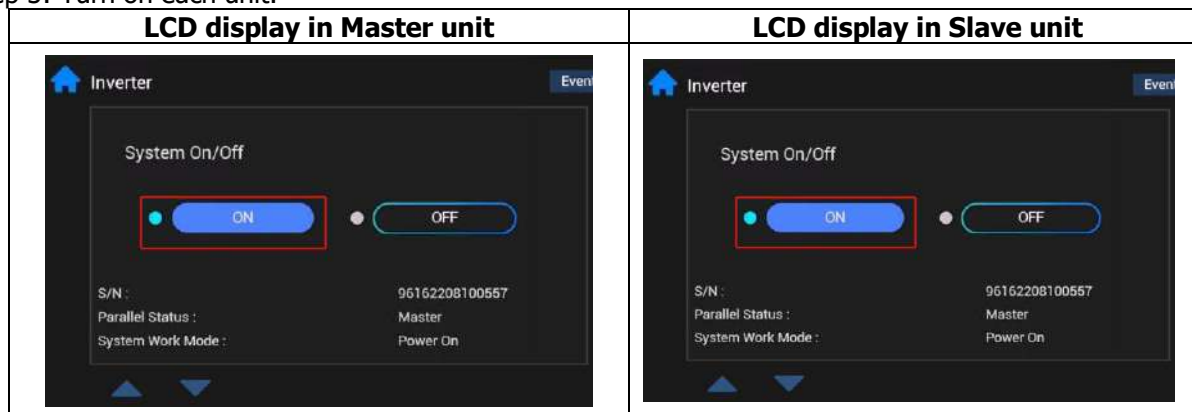

NOTE: Master and slave units are randomly defined.

Step 4: Switch on all AC breakers of Line wires in AC input. It's better to have all inverters connect to utility at the same time. If not, it will display fault 82 in following-order inverters. However, these inverters will automatically restart. If detecting AC connection, they will work normally.

Step 5: If there is no more fault alarm, the parallel system is completely installed.

Step 6: Please switch on all breakers of Line wires in load side. This system will start to provide power to the load.

Support three-phase equipment

Step 1: Check the following requirements before commissioning:

- Correct wire connection
- Ensure all breakers in Line wires of load side are open and each Neutral wires of each unit are connected together.

Step 2: Turn on all units and configure LCD Setting-Output Setting as Phase 1, Phase 2 and Phase 3 sequentially. And then shut down all units.

NOET: It's necessary to turn off switch when setting LCD program. Otherwise, the setting can not be programmed.

Step 3: Turn on all units sequentially.

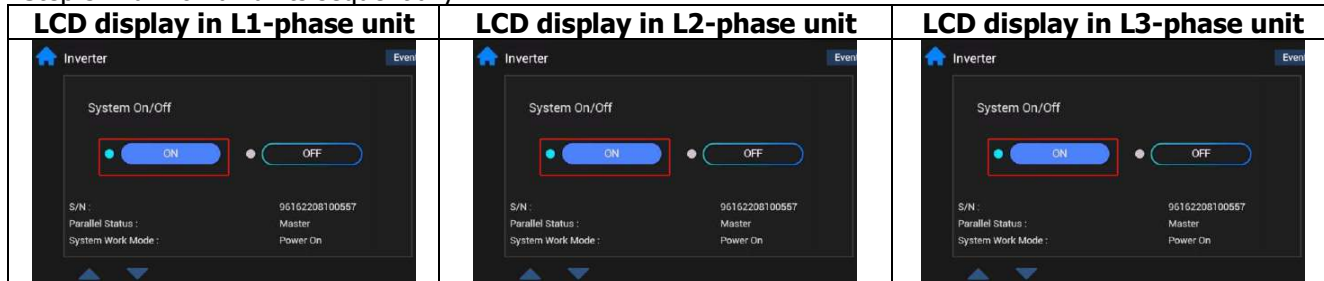

Step 4: Switch on all AC breakers of Line wires in AC input. If AC connection is detected and three phases are matched with unit setting, they will work normally. Otherwise, the AC icon will flash and they will not work in line mode.

Step 5: If there is no more fault alarm, the system to support 3-phase equipment is completely installed.

Step 6: Please switch on all breakers of Line wires in load side. This system will start to provide power to the load.

Note 1: To avoid overload occurring, before turning on breakers in load side, it's better to have whole system in operation first.

Note 2: Transfer time for this operation exists. Power interruption may happen to critical devices, which cannot bear transfer time.

8. Trouble shooting

Situation		Solution
Fault Code	Fault Event Description	
60	Current feedback into the inverter is detected.	<ol style="list-style-type: none"> Restart the inverter. Check if L/N cables are not connected reversely in all inverters. For parallel system in single phase, make sure the sharing are connected in all inverters. For supporting three-phase system, make sure the sharing cables are connected in the inverters in the same phase, and disconnected in the inverters in different phases. If the problem remains, please contact your installer.
71	The firmware version of each inverter is not the same.	<ol style="list-style-type: none"> Update all inverter firmware to the same version. Check the version of each inverter via LCD setting and make sure the CPU versions are same. If not, please contact your instraller to provide the firmware to update. After updating, if the problem still remains, please contact your installer.
72	The output current of each inverter is different.	<ol style="list-style-type: none"> Check if sharing cables are connected well and restart the inverter. If the problem remains, please contact your installer.
80	CAN data loss	<ol style="list-style-type: none"> Check if communication cables are connected well and restart the inverter. If the problem remains, please contact your installer.
81	Host data loss	
82	Synchronization data loss	
83	The battery voltage of each inverter is not the same.	<ol style="list-style-type: none"> Make sure all inverters share same groups of batteries together. Remove all loads and disconnect AC input and PV input. Then, check battery voltage of all inverters. If the values from all inverters are close, please check if all battery cables are the same length and same material type. Otherwise, please contact your installer to provide SOP to calibrate battery voltage of each inverter. If the problem still remains, please contact your installer.
84	AC input voltage and frequency are detected different.	<ol style="list-style-type: none"> Check the utility wiring connction and restart the inverter. Make sure utility starts up at same time. If there are breakers installed between utility and inverters, please be sure all breakers can be turned on AC input at same time. If the problem remains, please contact your installer.
85	AC output current unbalance	<ol style="list-style-type: none"> Restart the inverter. Remove some excessive loads and re-check load information from LCD of inverters. If the values are different, please check if AC input and output cables are in the same length and material type. If the problem remains, please contact your installer.
86	AC output mode setting is different.	<ol style="list-style-type: none"> Switch off the inverter and check LCD setting #28. For parallel system in single phase, make sure no 3P1, 3P2 or 3P3 is set on #28. For supporting three-phase system, make sure no "PAL" is set on #28. If the problem remains, please contact your installer.
87	Single Machine exists in parallel system	<ol style="list-style-type: none"> Check whether a single machine exists in parallel system.

Appendix II: BMS Communication Installation

1. Introduction

If connecting to lithium battery, it is recommended to purchase a custom-made RJ45 communication cable. Please check with your dealer or integrator for details.

This custom-made RJ45 communication cable delivers information and signal between lithium battery and the inverter. These information are listed below:

- Re-configure charging voltage, charging current and battery discharge cut-off voltage according to the lithium battery parameters.
- Have the inverter start or stop charging according to the status of lithium battery.

2. Pin Assignment for BMS Communication Port

	Definition
PIN 1	RS232TX
PIN 2	RS232RX
PIN 3	RS485B
PIN 4	NC
PIN 5	RS485A
PIN 6	CANH
PIN 7	CANL
PIN 8	GND

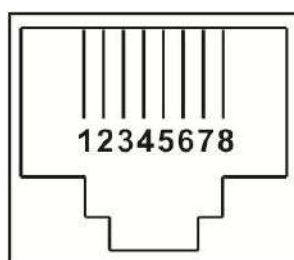

3. Lithium Battery Communication Configuration

LIO-4805/LIO-4810-150A

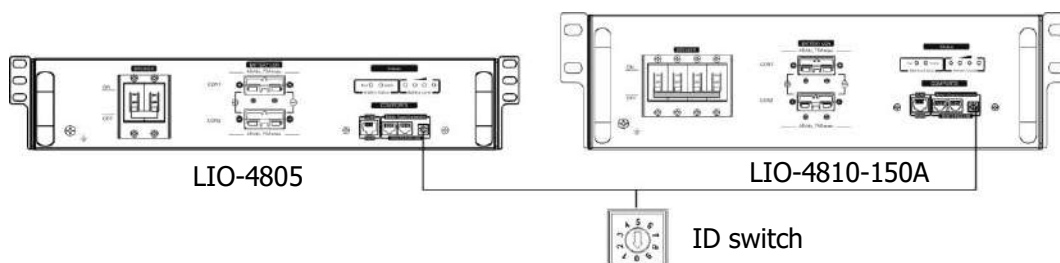

LIO-II 4810

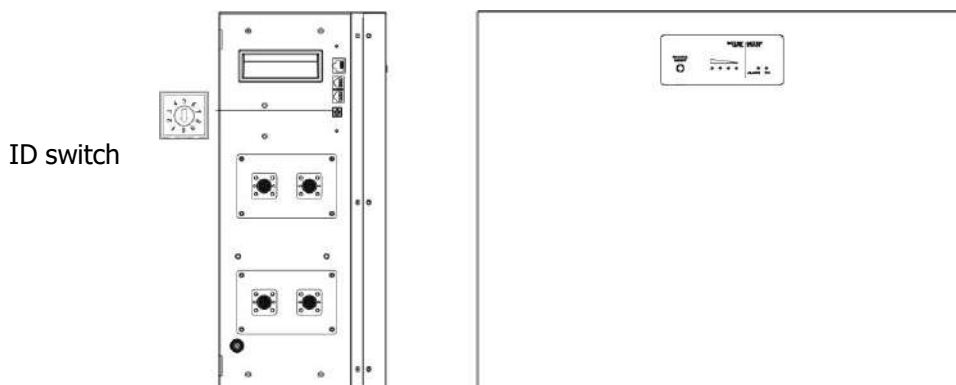

ID Switch indicates the unique ID code for each battery module. It's required to assign a unique ID to each battery module for normal operation. We can set up the ID code for each battery module by rotating the PIN number on the ID switch. From number 0 to 9, the number can be random; no particular order. Maximum 10 battery modules can be operated in parallel.

PYLONTECH

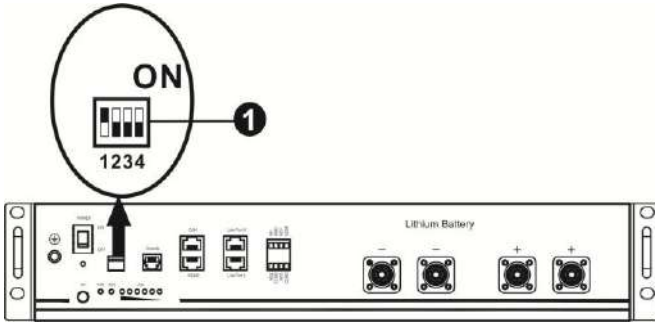

Dip Switch: There are 4 Dip Switches that sets different baud rate and battery group address. If switch position is turned to the "OFF" position, it means "0". If switch position is turned to the "ON" position, it means "1".

Dip 1 is "ON" to represent the baud rate 9600.

Dip 2, 3 and 4 are to set up battery group address.

Dip switch 2, 3 and 4 on master battery (first battery) are to set up or change the group address.

NOTE: "1" is upper position and "0" is bottom position.

Dip 1	Dip 2	Dip 3	Dip 4	Group address
1: RS485 baud rate=9600 Restart to take effect	0	0	0	Single group only. It's necessary to set up master battery with this setting and slave batteries are unrestricted.
	1	0	0	Multiple group condition. It's necessary to set up master battery on the first group with this setting and slave batteries are unrestricted.
	0	1	0	Multiple group condition. It's necessary to set up master battery on the second group with this setting and slave batteries are unrestricted.
	1	1	0	Multiple group condition. It's necessary to set up master battery on the third group with this setting and slave batteries are unrestricted.
	0	0	1	Multiple group condition. It's necessary to set up master battery on the forth group with this setting and slave batteries are unrestricted.
	1	0	1	Multiple group condition. It's necessary to set up master battery on the fifth group with this setting and slave batteries are unrestricted.

NOTE: The maximum groups of lithium battery is 5 and for maximum number for each group, please check with battery manufacturer.

4. Installation and Operation

LIO-4805/LIO-4810-150A/ESS LIO-I 4810

After ID no. is assigned for each battery module, please set up LCD panel in inverter and install the wiring connection as following steps.

Step 1: Use supplied RJ11 signal cable to connect into the extension port (P1 or P2).

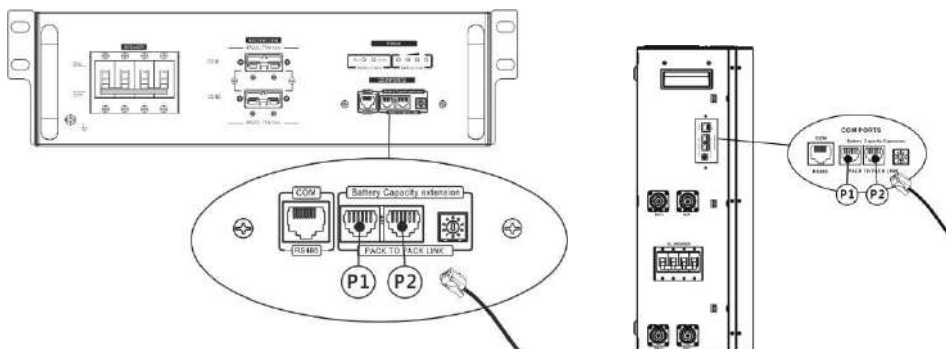

Step 2: Use supplied RJ45 cable (from battery module package) to connect inverter and Lithium battery.

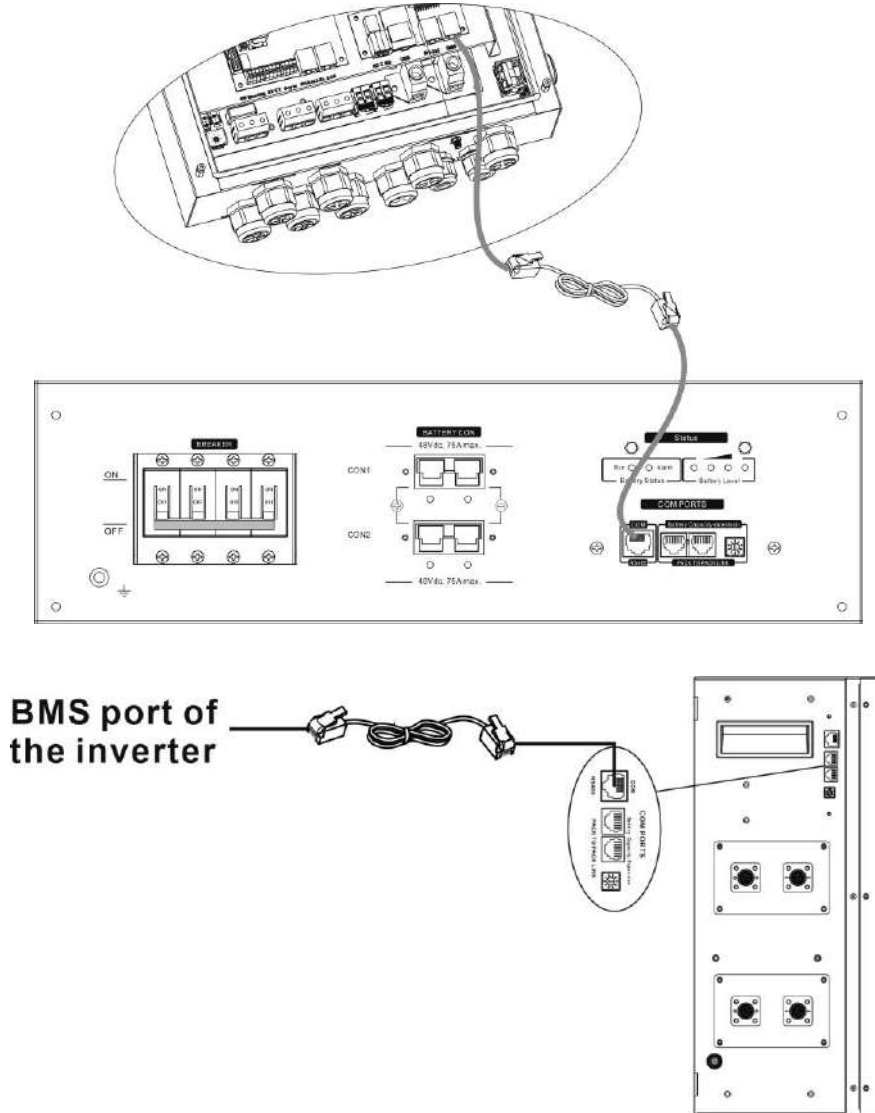

* For multiple battery connection, please check battery manual for the details.

Note for parallel system:

1. Only support common battery installation.
2. Use custom-made RJ45 cable to connect any inverter (no need to connect to a specific inverter) and Lithium battery. Simply set this inverter battery type to "LIB" in LCD program 5. Others should be "USE".

Step 3: Turn the breaker switch "ON". Now, the battery module is ready for DC output.

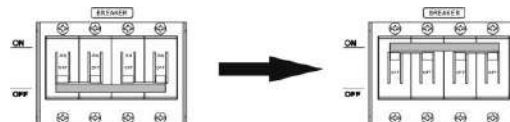



Step 4: Press Power on/off button on battery module for 5 secs, the battery module will start up.

*If the manual button cannot be approached, just simply turn on the inverter module. The battery module will be automatically turned on.

Step 5: Turn on the inverter.

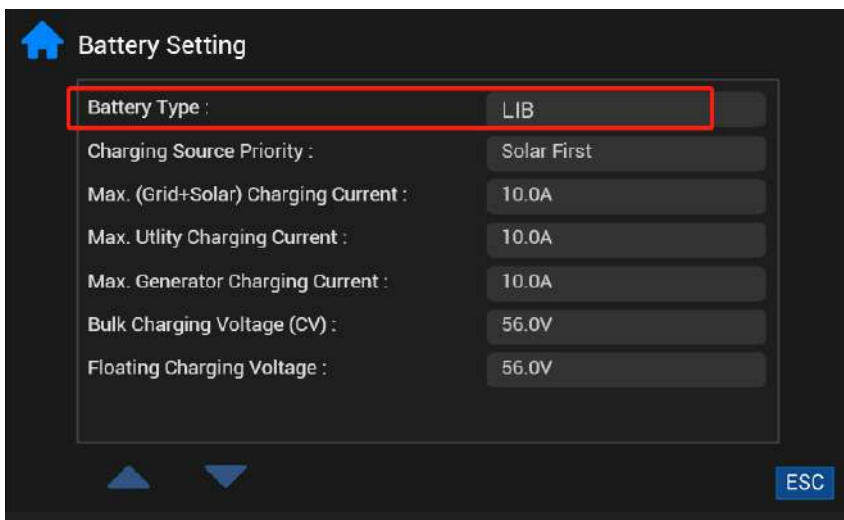
Step 6. Be sure to select battery type as "LIB" in battery Setting.



If communication between the inverter and battery is successful, the BMS icon  on LCD display will light on. Generally speaking, it will take longer than 1 minute to establish communication.

PYLONTECH

After configuration, please set up LCD panel in inverter and make wiring connection to Lithium battery as the following steps.

Step 1. Use custom-made RJ45 cable to connect inverter and Lithium battery.

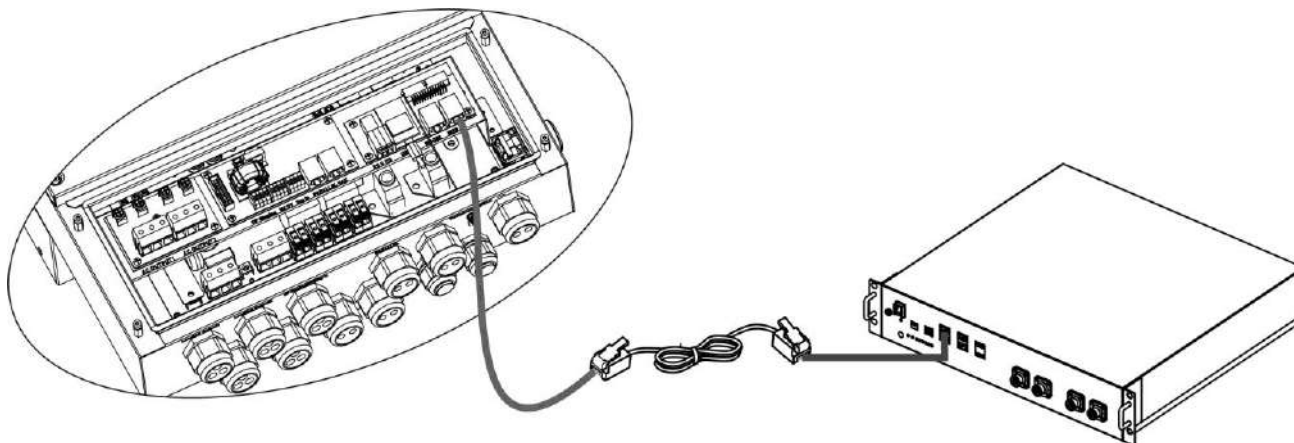

Note for parallel system:

- 3. Only support common battery installation.
- 4. Use custom-made RJ45 cable to connect any inverter (no need to connect to a specific inverter) and Lithium battery. Simply set this inverter battery type to "PYL" in LCD program 5. Others should be "USE".

Step 2. Switch on Lithium battery.

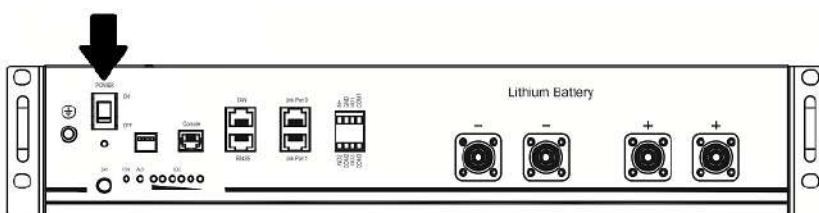

Step 3. Press more than three seconds to start Lithium battery, power output ready.

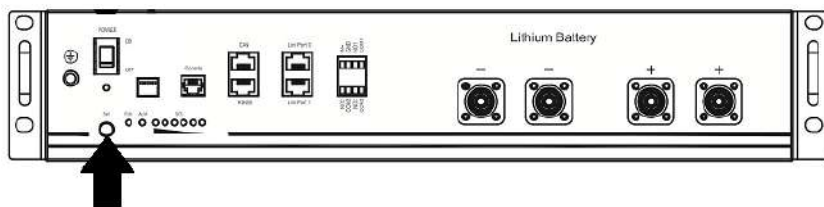

Step 4. Turn on the inverter.

Step 5. Be sure to select battery type as "PYL" in battery Setting.

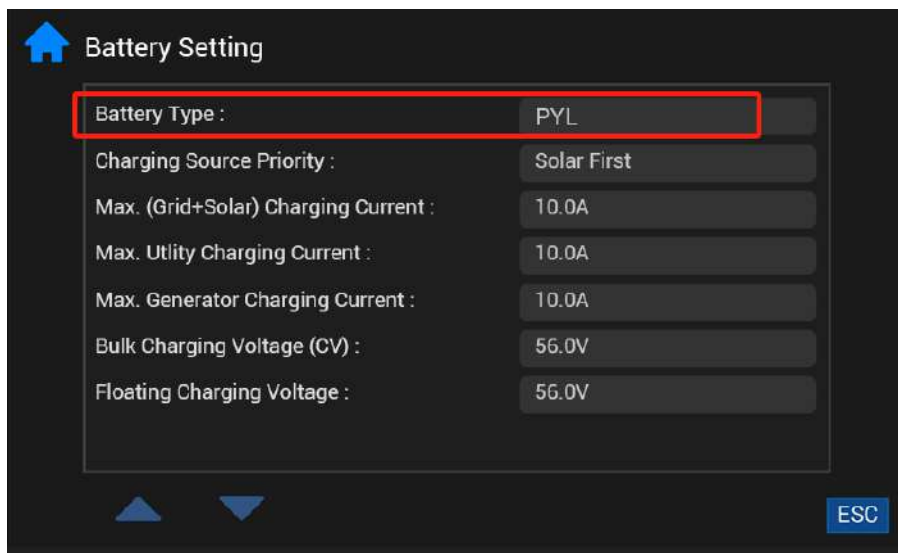

WECO

Step 1. Use custom-made RJ45 cable to connect inverter and Lithium battery.

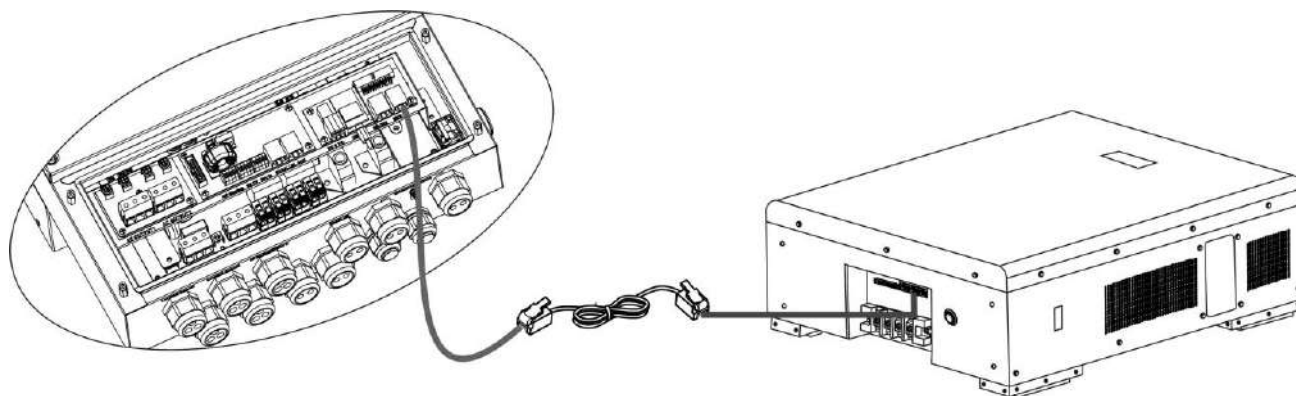

Note for parallel system:

1. Only support common battery installation.
2. Use custom-made RJ45 cable to connect any inverter (no need to connect to a specific inverter) and Lithium battery. Simply set this inverter battery type to "WECO" in LCD program 5. Others should be "USE".

Step 2. Switch on Lithium battery.

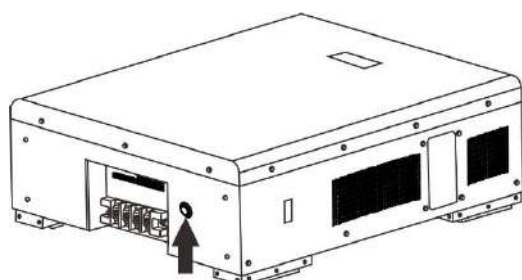

Step 3. Turn on the inverter.

Step 4. Be sure to select battery type as "WEC" in battery Setting.

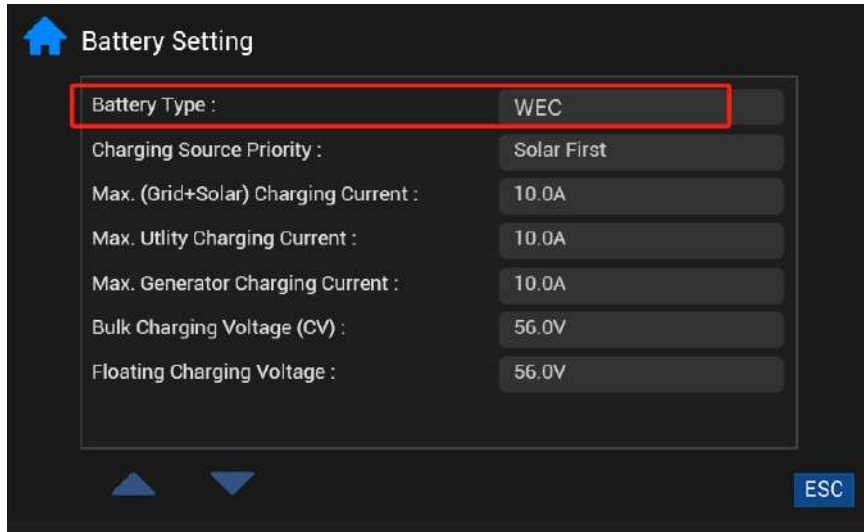

SOLTARO

Step 1. Use custom-made RJ45 cable to connect inverter and Lithium battery.

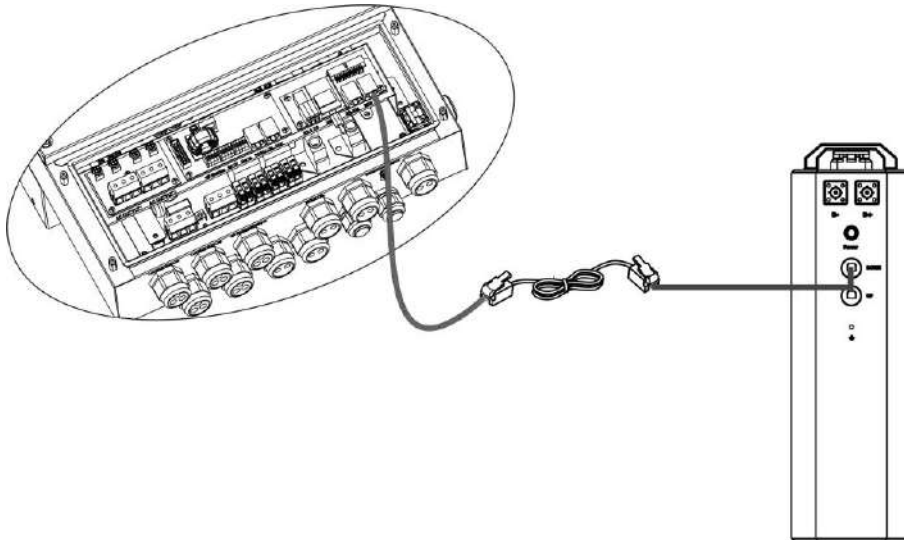

Note for parallel system:

1. Only support common battery installation.
2. Use custom-made RJ45 cable to connect any inverter (no need to connect to a specific inverter) and Lithium battery. Simply set this inverter battery type to "SOL" in LCD program 5. Others should be "USE".

Step 2. Open DC isolator and switch on Lithium battery.

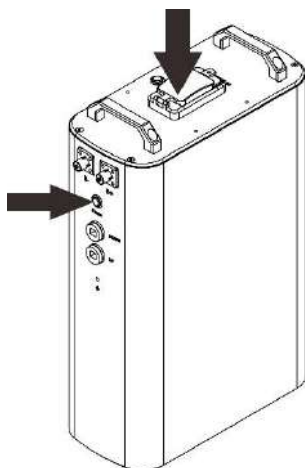

Step 3. Turn on the inverter.

Step 4. Be sure to select battery type as "SOL" in battery Setting.

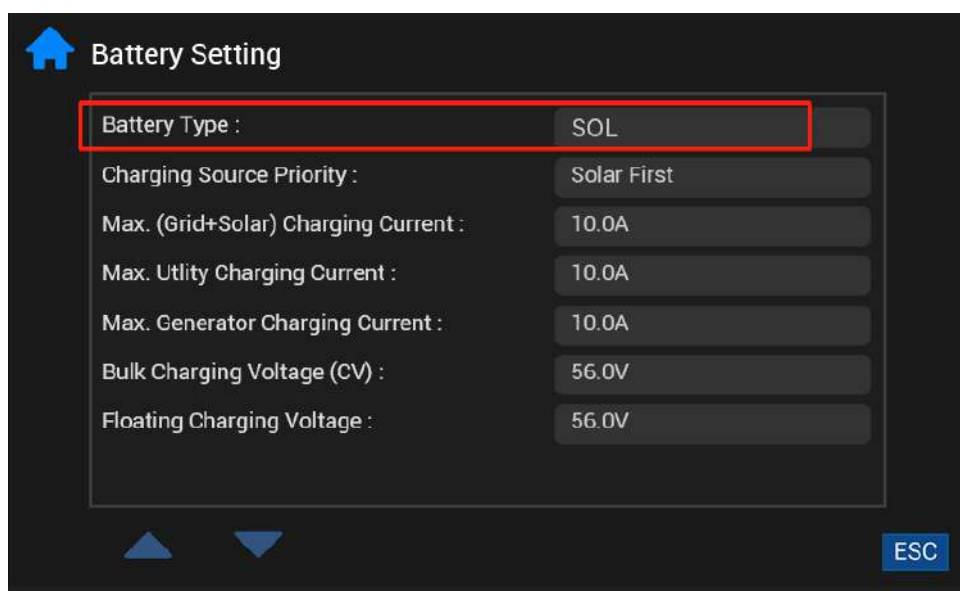

Appendix III: The Wi-Fi Operation Guide

Introduction

Wi-Fi module can enable wireless communication between solar inverters and the monitoring platform. Users can remotely monitor and control their inverters when they combine the Wi-Fi module with Energy-Mate APP. The App uses the Wi-Fi chip to provide remote monitoring data services, which is beneficial for the daily data monitoring of the inverter, querying the real-time data in the device, sending commands from the device, and operating the device remotely. The app is available for both iOS and Android.

Energy-Mate App

Download and install APP

Please find "Energy-Mate" app from Apple® store or Google® Play Store. Install this app in your mobile phone.



Or scan the following QR code with your smart phone and download Energy-Mate App.



(Android system)



(iOS system)

Initial Setup

You can choose local Wi-Fi or Bluetooth to configure the Wi-Fi module network through Energy-mate APP.

Local Wi-Fi Configuration

If you have configured the network through Bluetooth, please skip this section.

- Turn on the unit.
- Open the Wi-Fi settings from your smart phone.
- Connect your smart phone to the Wi-Fi module. The Wi-Fi module PN number is 18 digits.
- Default password for the Wi-Fi module is: 12345678.

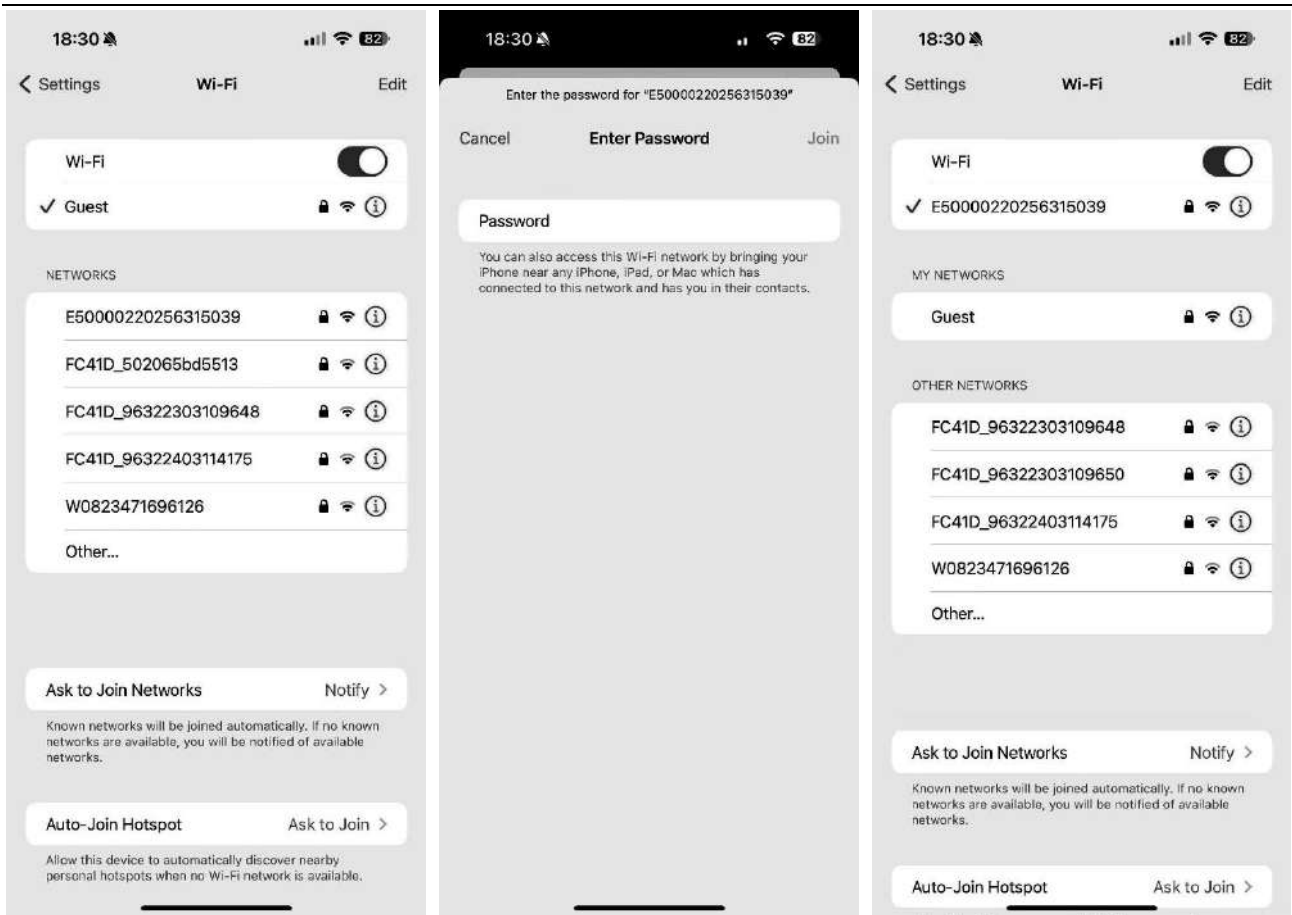

- Once the Wi-Fi connection is successful, click the Energy-Mate APP installed in the phone to enter the login page. Then, click the "Toolbox" and choose "Wi-Fi Config" to enter the Wi-Fi configuration page.

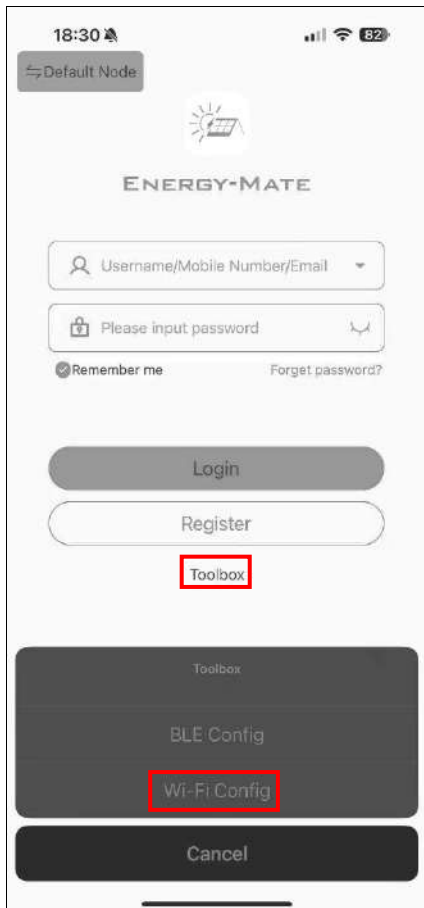

- After entering the Wi-Fi configuration page, please note that the connected Wi-Fi name **must** be the **same as your Wi-Fi module PN number**, and the status **must** be **connected**. If not, please return to the login page, connect your smart phone to the Wi-Fi module, and re-enter the Wi-Fi configuration page.

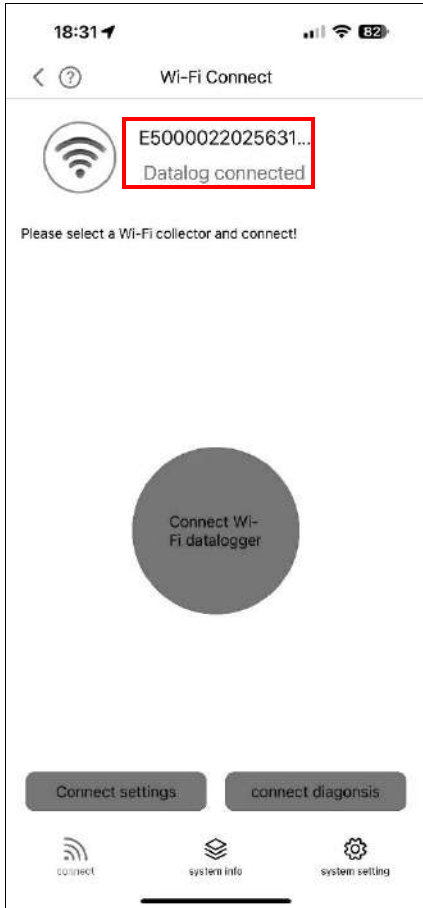
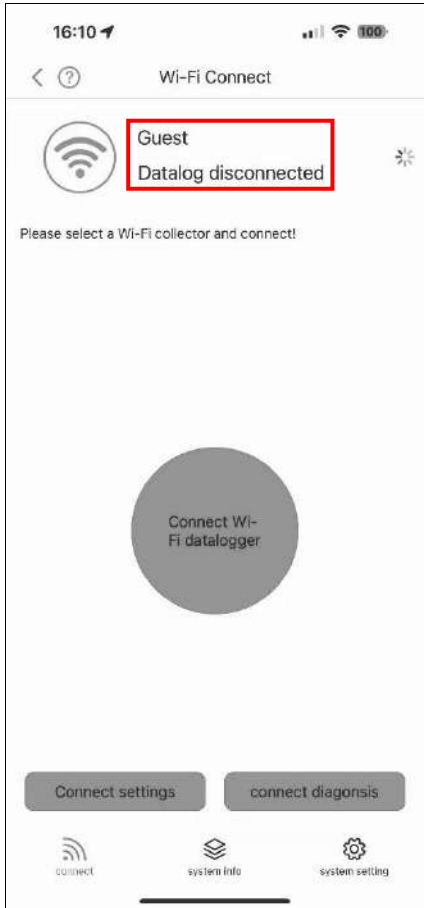
The Wi-Fi module connection is successfully	The Wi-Fi module connection failed
<p>You can proceed to the next step to configure the network.</p> 	<p>Please return to the login page, connect your smart phone to the Wi-Fi module, and re-enter the Wi-Fi configuration page.</p> 

- Click "Connect settings" to manually enter the router name or click  to choose the router name. Then, enter the router password and click the "Setting" to complete the setting. The Wi-Fi module only could connect the router at **2.4GHz**.

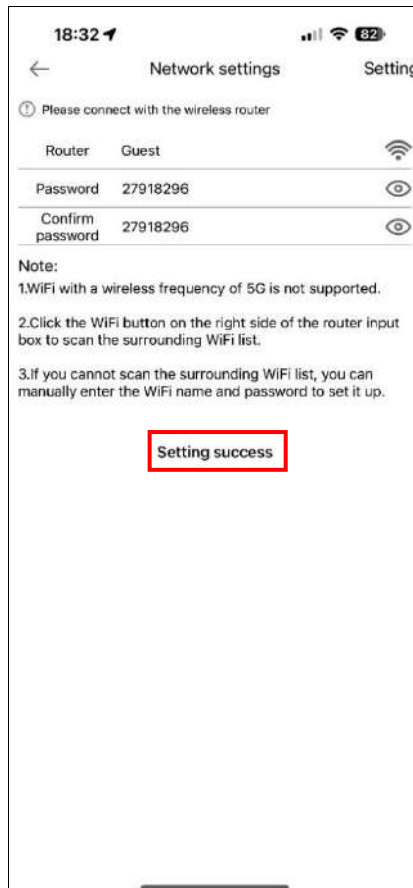
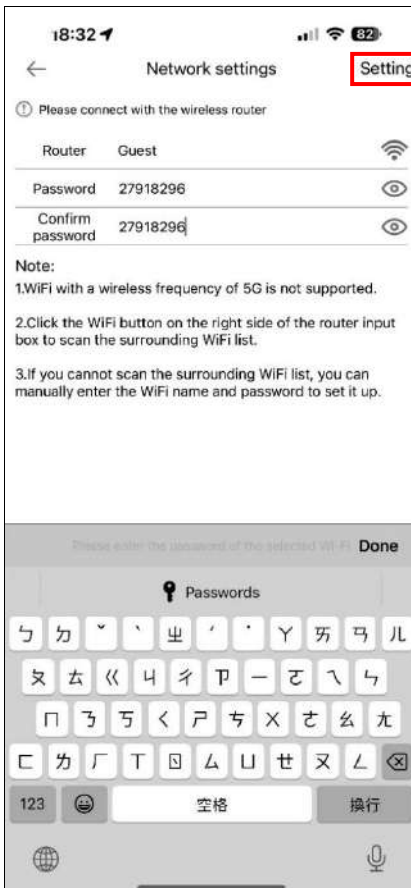
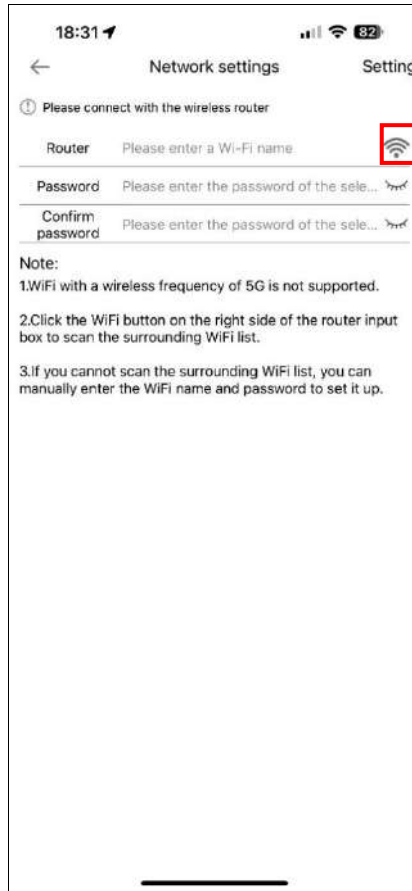
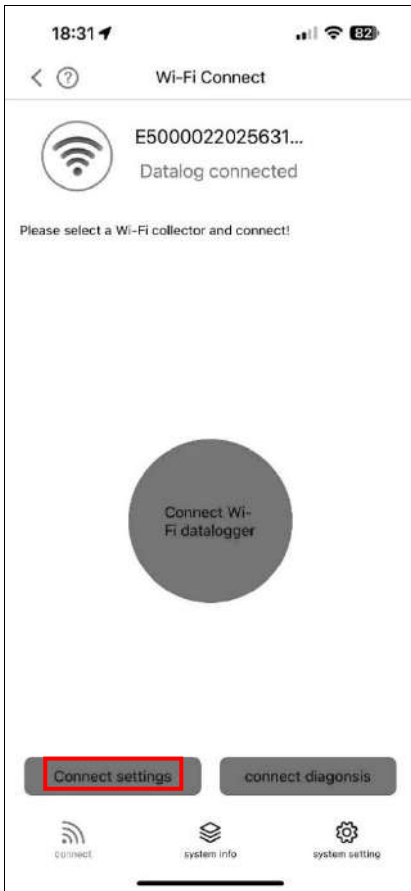

- Click  to return to the Wi-Fi configuration page. Click "Connect diagnosis" to check the connection status.

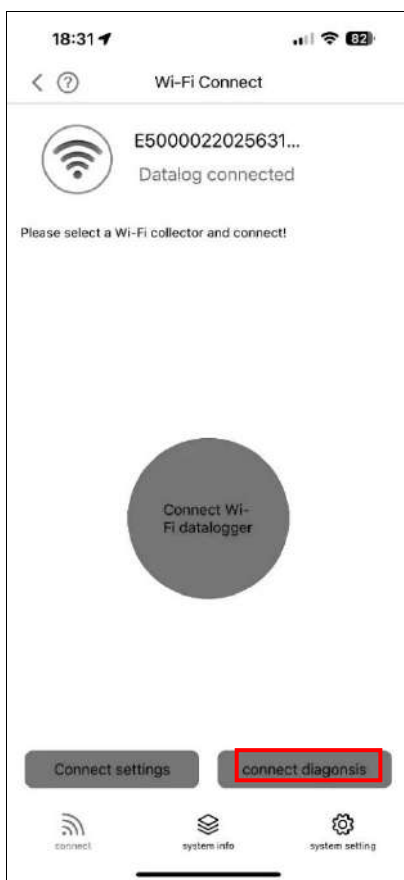
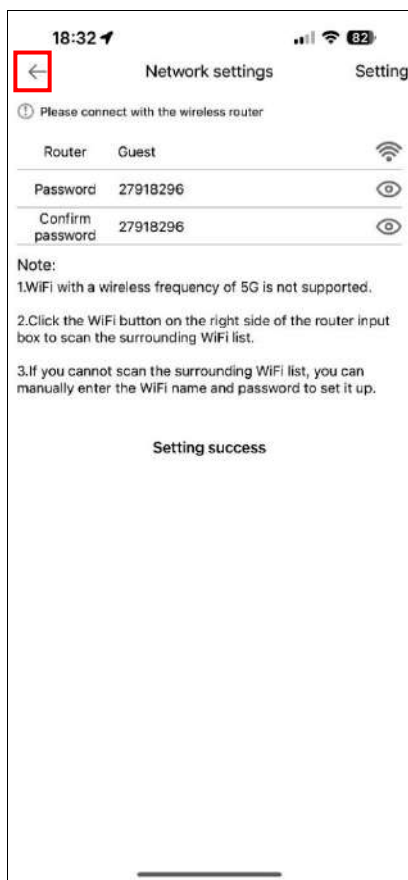

The configuration is **successfully**

The configuration **failed**

Green lines between device, datalogger, router, and server.

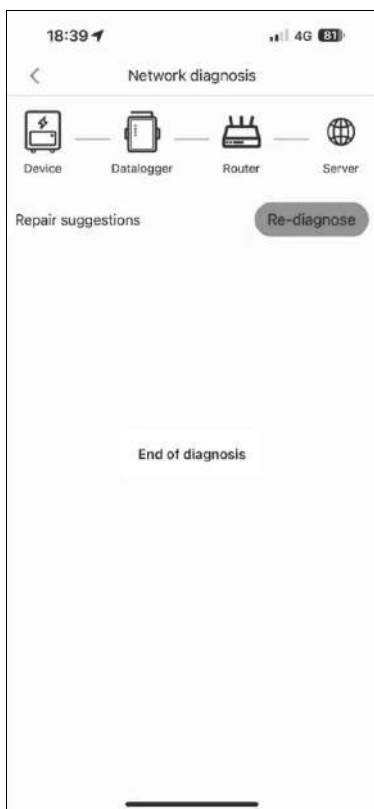

Red crosses between device, datalogger, router, and server. Please refer to APP instructions to re-configure.

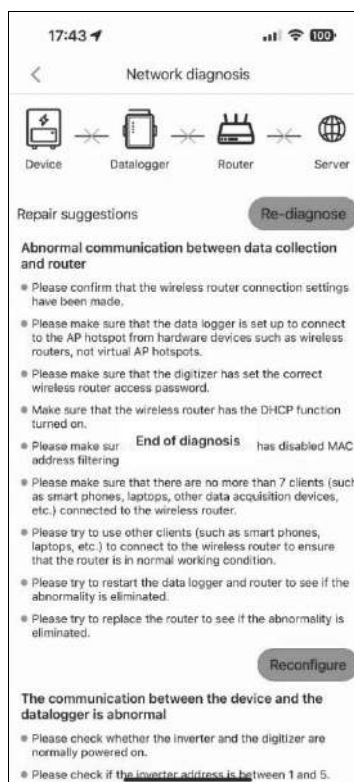

- After Wi-Fi configuration, please **forget** the Wi-Fi module of the Wi-Fi connection on the smartphone to avoid automatic connection and unable to access the network. The login page will prompt "Server not found".

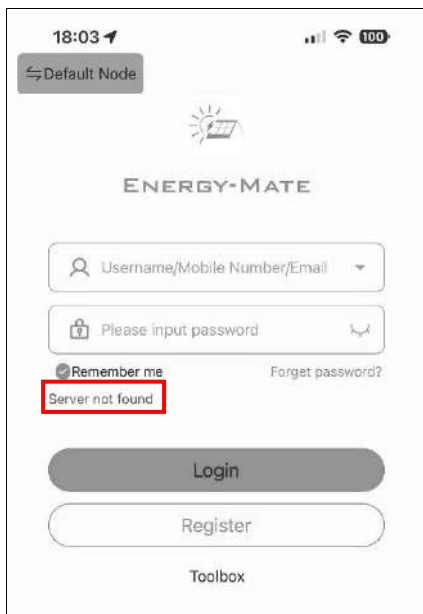

Bluetooth Configuration

If you have configured the network through Wi-Fi, please skip this section.

- Turn on the unit.
- Open the Bluetooth from your smart phone.
- Click the Energy-Mate APP installed in the phone to enter the login page. Then, click the "Toolbox" and

choose "BLE Config" to enter the Bluetooth configuration page.

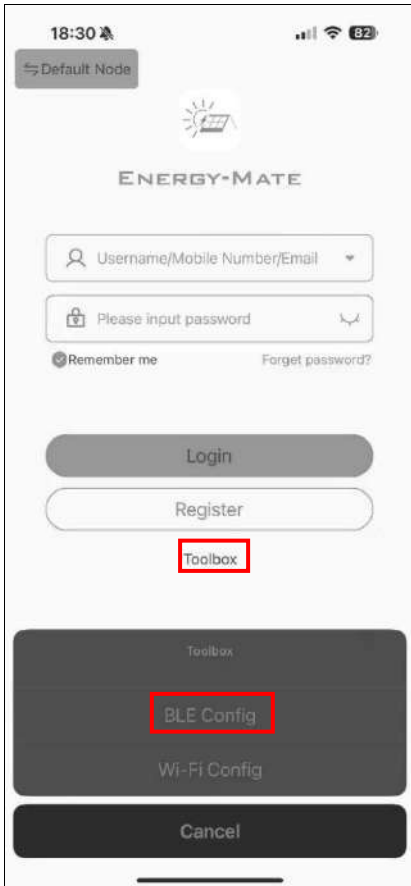

- Connect your smart phone to the Wi-Fi module through Bluetooth.

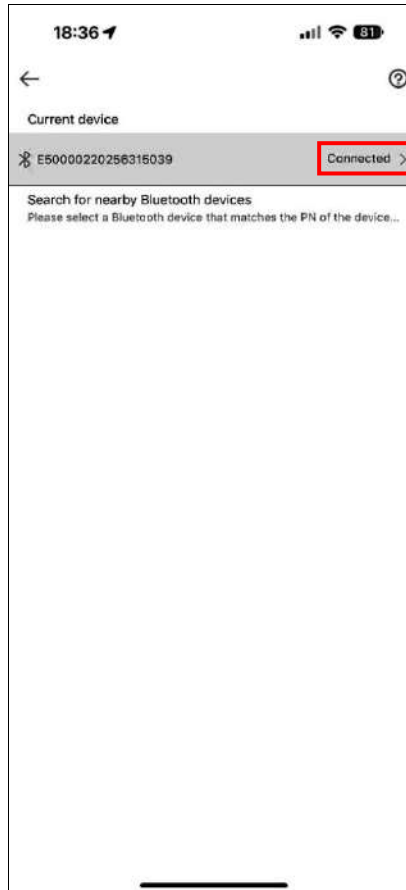
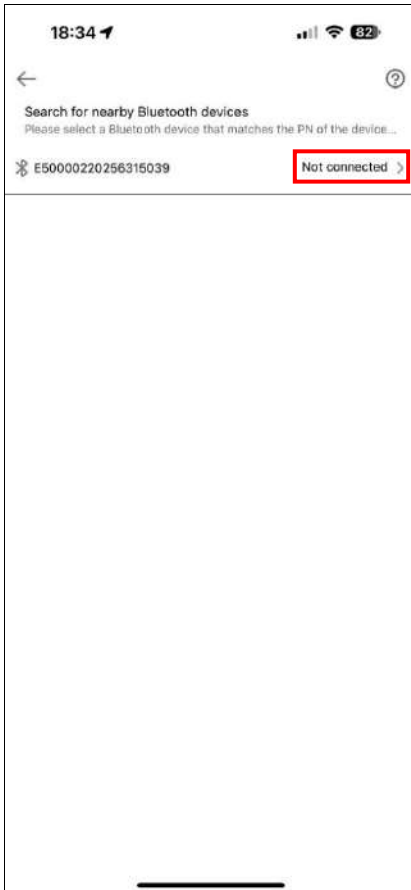

- Manually enter the router name or click  to choose the router name, enter the router password, and then click the "Setting" to complete the setting.
The Wi-Fi module only could connect the router at **2.4GHz**.

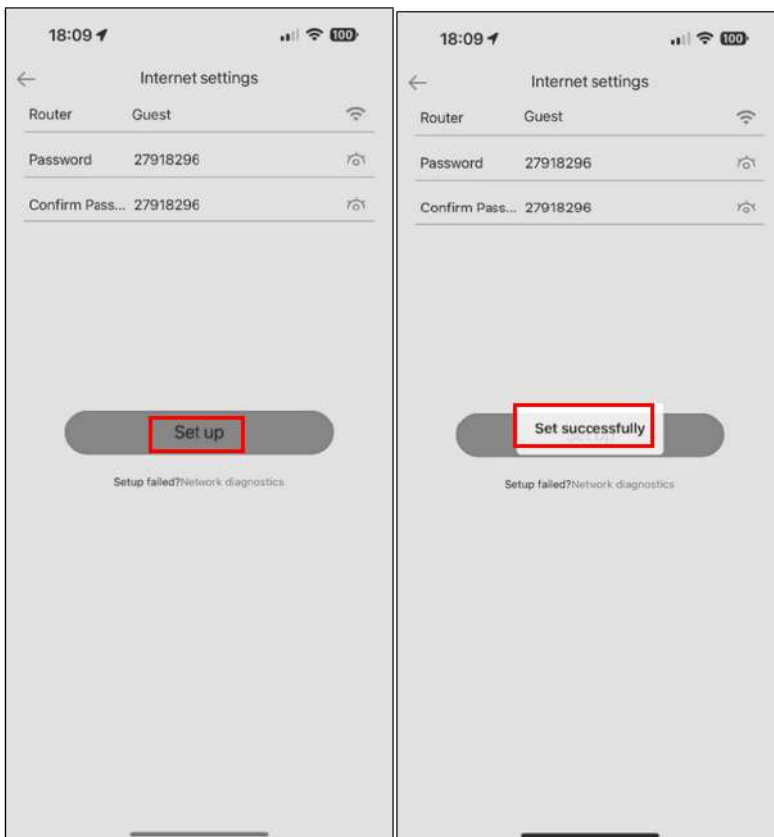
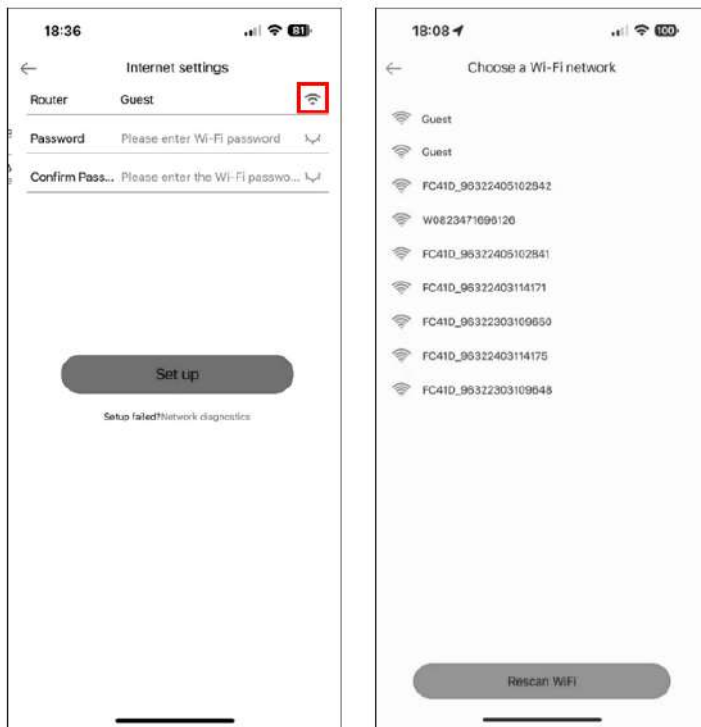

- Click "Network diagnosis" to check the connection status.

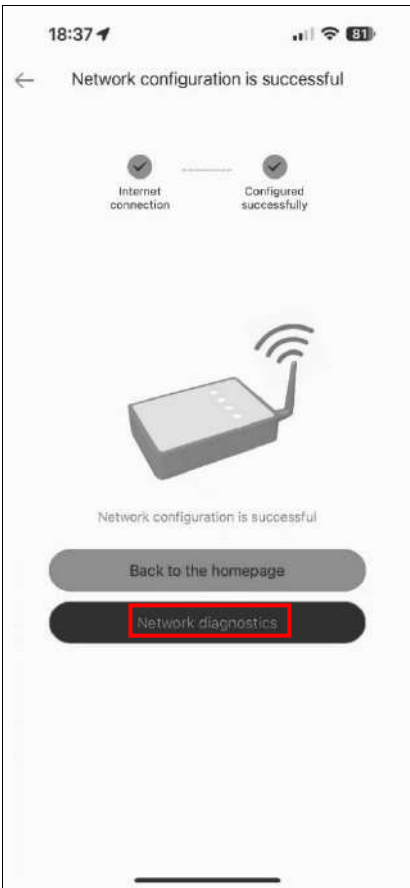

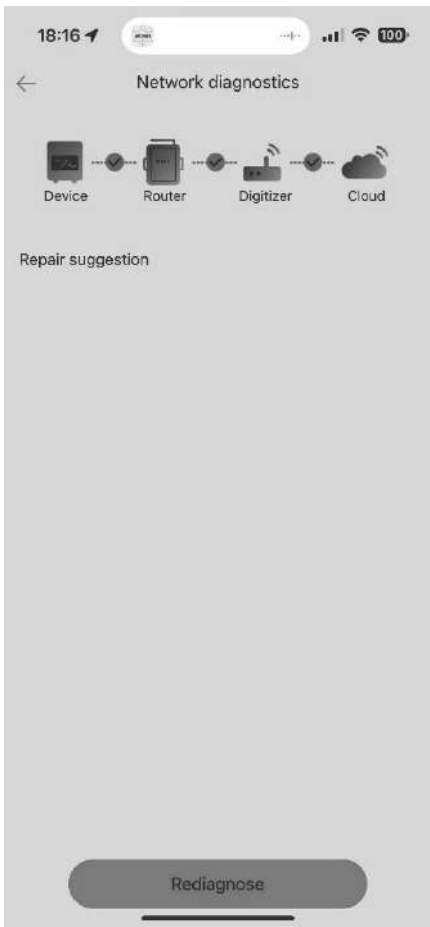
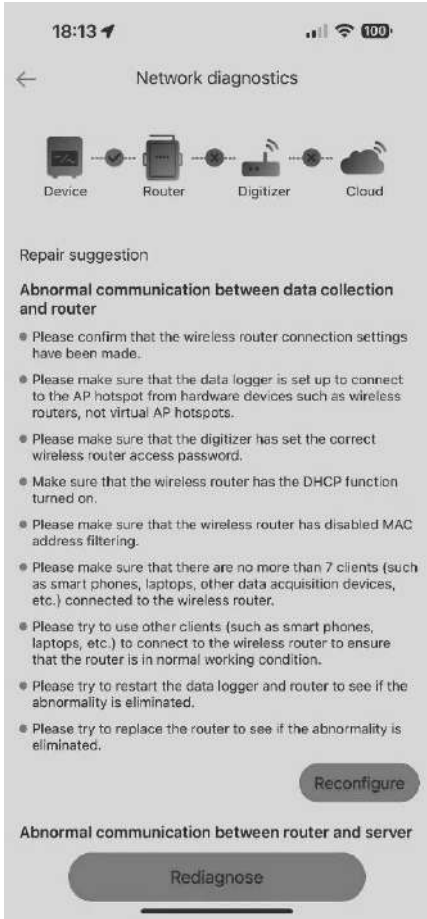
The configuration is successfully	The configuration failed
<p>Green lines between device, datalogger, router, and server.</p> 	<p>Red crosses between device, datalogger, router, and server. Please refer to APP instructions to reconfigure.</p> 

- After Bluetooth configuration, please **disconnect** the Wi-Fi module of the Bluetooth connection on the smartphone to avoid automatic connection and unable to access the network. The login page will prompt "Server not found".

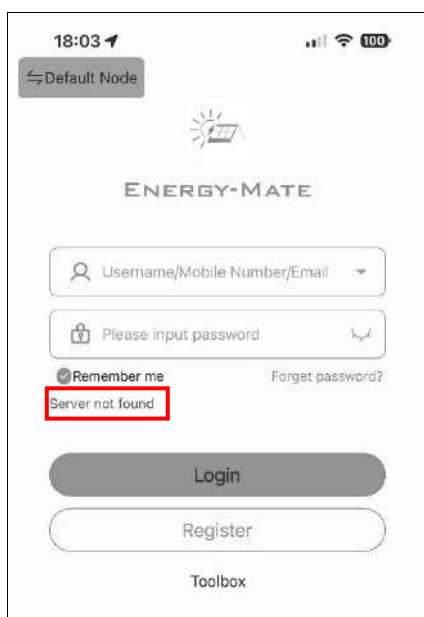

Registration and login

- Connect your smart phone to the router.
- Registration at first time.
- Click the "Register" to enter registration page and fill in the information. Once registration is complete, click "Sign in" or click  to return to the home page. Then, enter the registered username and password to log in.

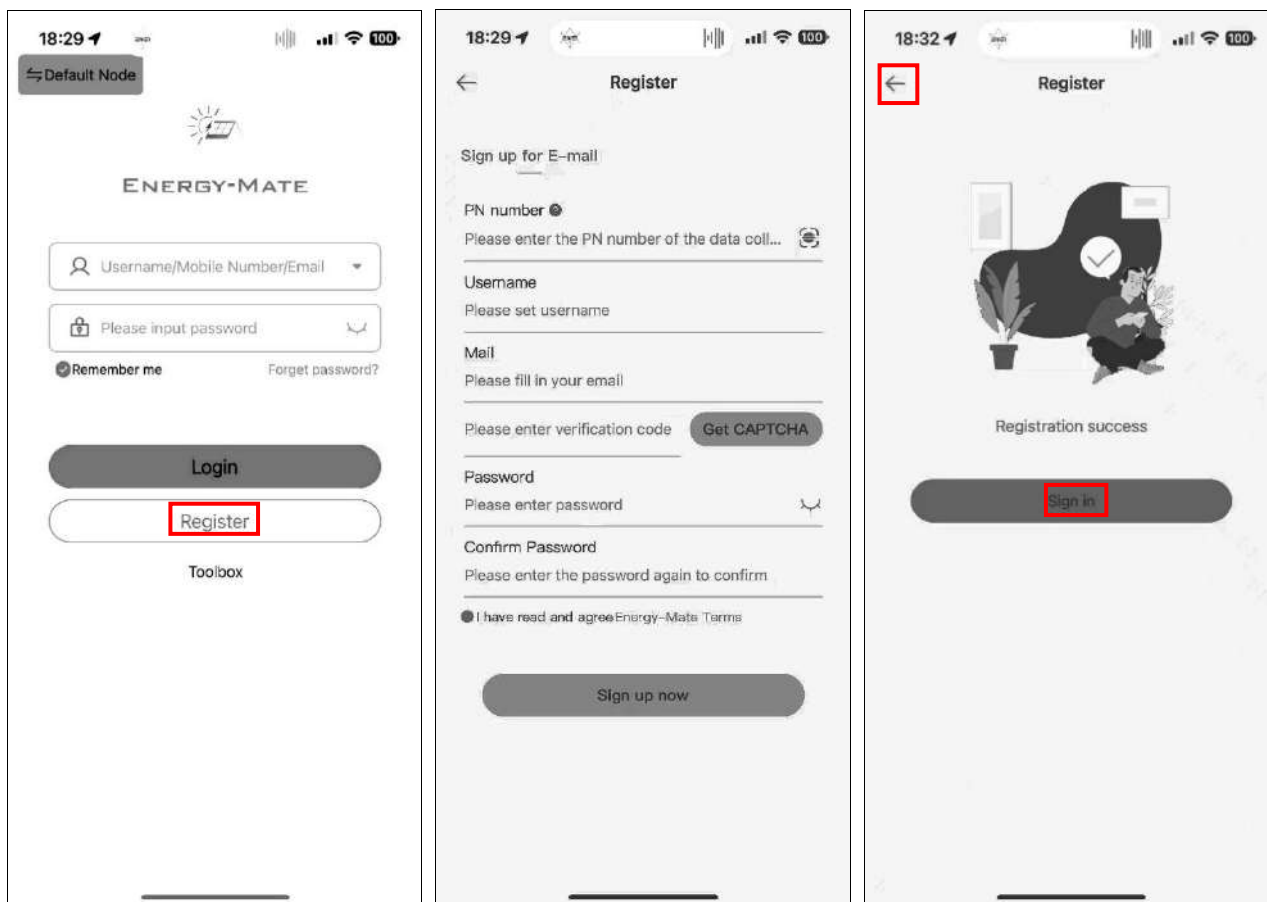

Datalogger

- After login, the default Home page will appear.
- Choose Datalogger page to see the Wi-Fi module list.
 - ◆ Gray icon means Wi-Fi module is offline. Please refer to 2-2 Initial Setup to choose local Wi-Fi or Bluetooth configure Wi-Fi module network.
 - ◆ Green icon means Wi-Fi module is online.



- Click  to see the Wi-Fi module information.

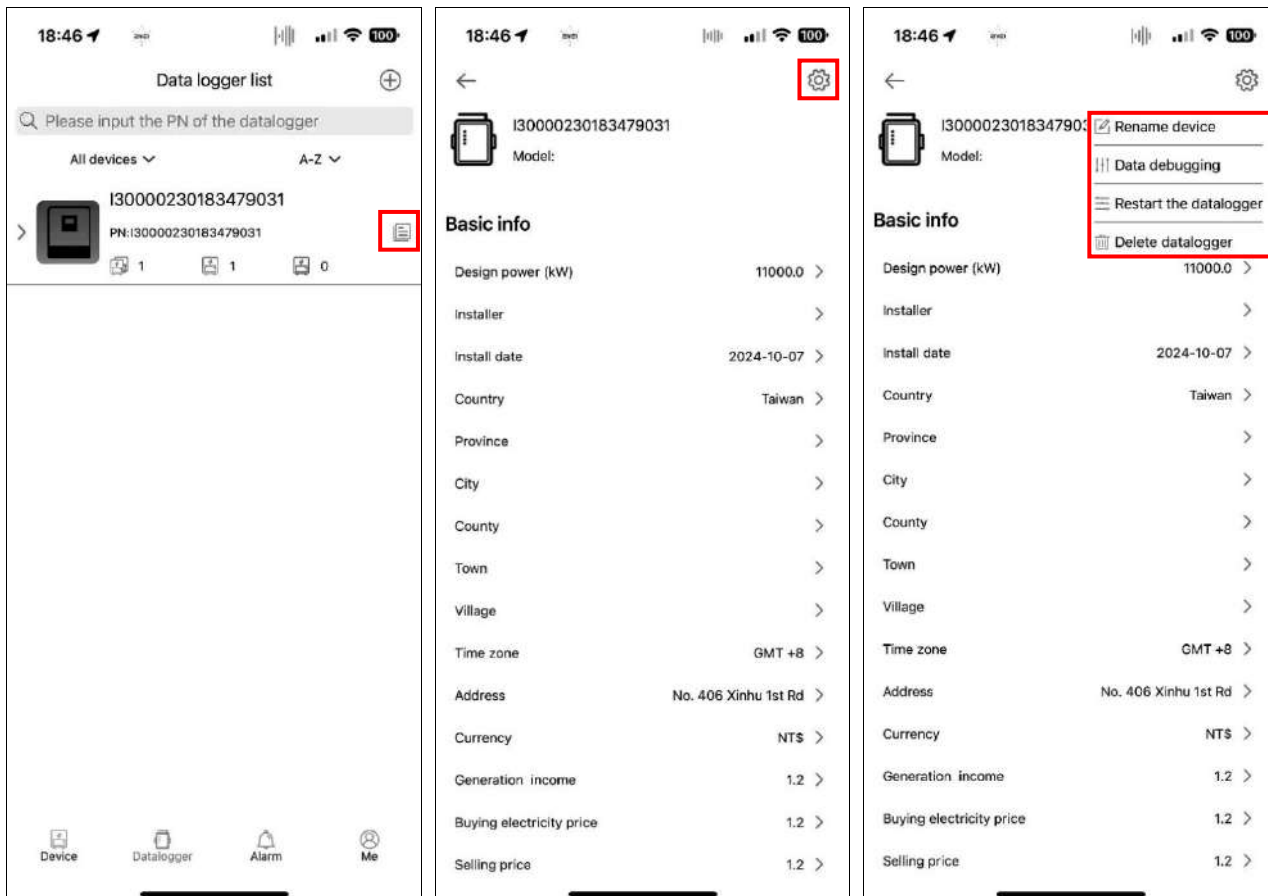

- Click  to rename device, data debugging, restart the datalogger, and delete datalogger.
 - ◆ Rename device: rename the Wi-Fi module name.
 - ◆ Data debugging: send RS232 commands to the inverter in hexadecimal format.
 - ◆ Restart the datalogger: restart the Wi-Fi module.
 - ◆ Delete datalogger: delete the Wi-Fi module. The inverter information in the device page will **also be deleted**. Once deleted, you **can** add datalogger under another account.

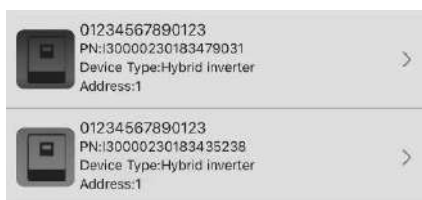

Device

- Choose Device page to see the inverter list.
 - ◆ Gray icon means inverter is offline.
 - ◆ Green icon means inverter is online and no warnings and faults.
 - ◆ Yellow icon means inverter is online and has a warning.
 - ◆ Red icon means inverter is online and has a fault.



- Click  to see the inverter information.
- Click  to rename device and delete device.
 - ◆ Rename device: rename the inverter name.

- ◆ Delete device: delete the inverter. The Wi-Fi module information in the datalogger page will **not be deleted**. Even if deleted, you **cannot** add Wi-Fi module under another account.

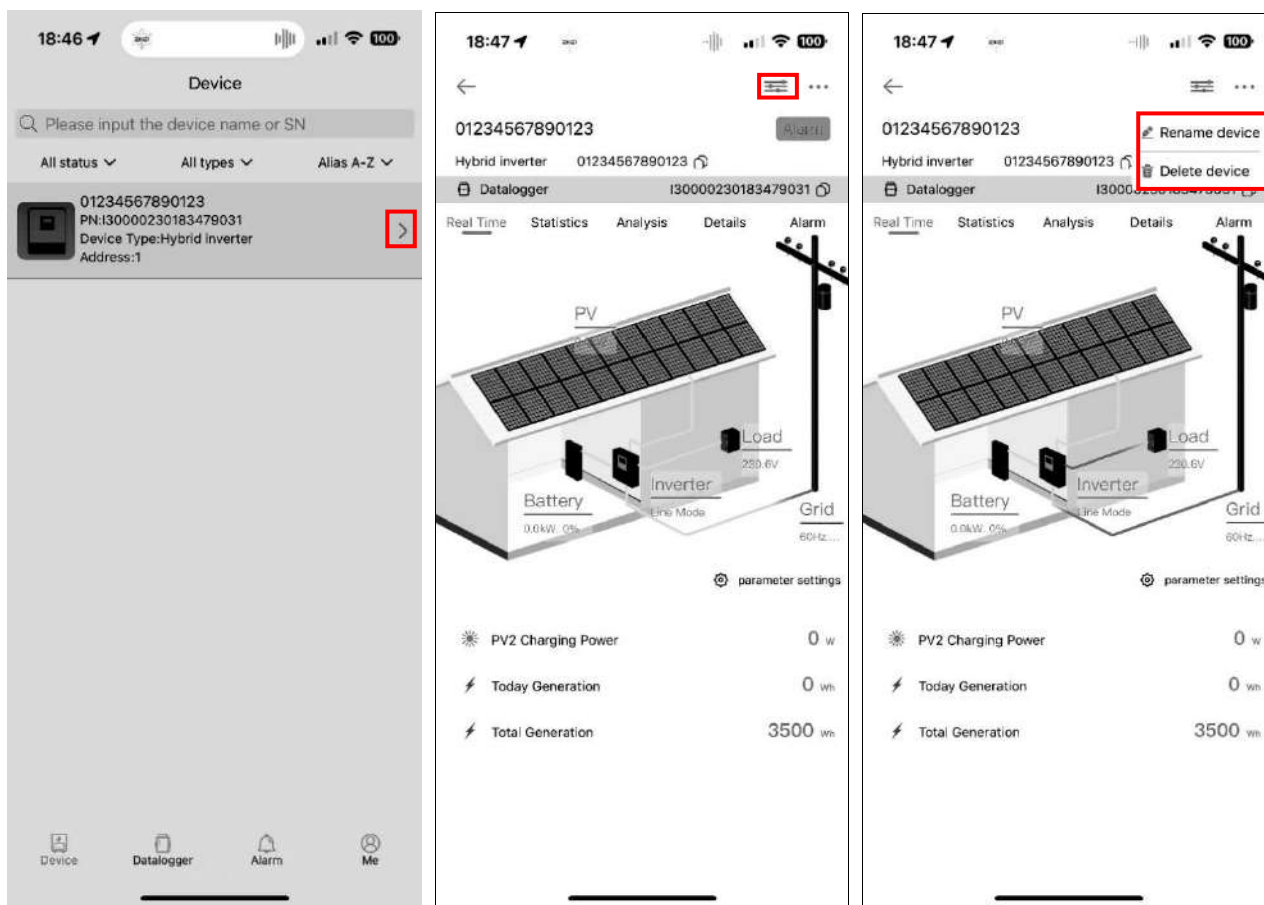

- Click  to enter setting parameters page. The setting items on the parameter page will be different based on different models.

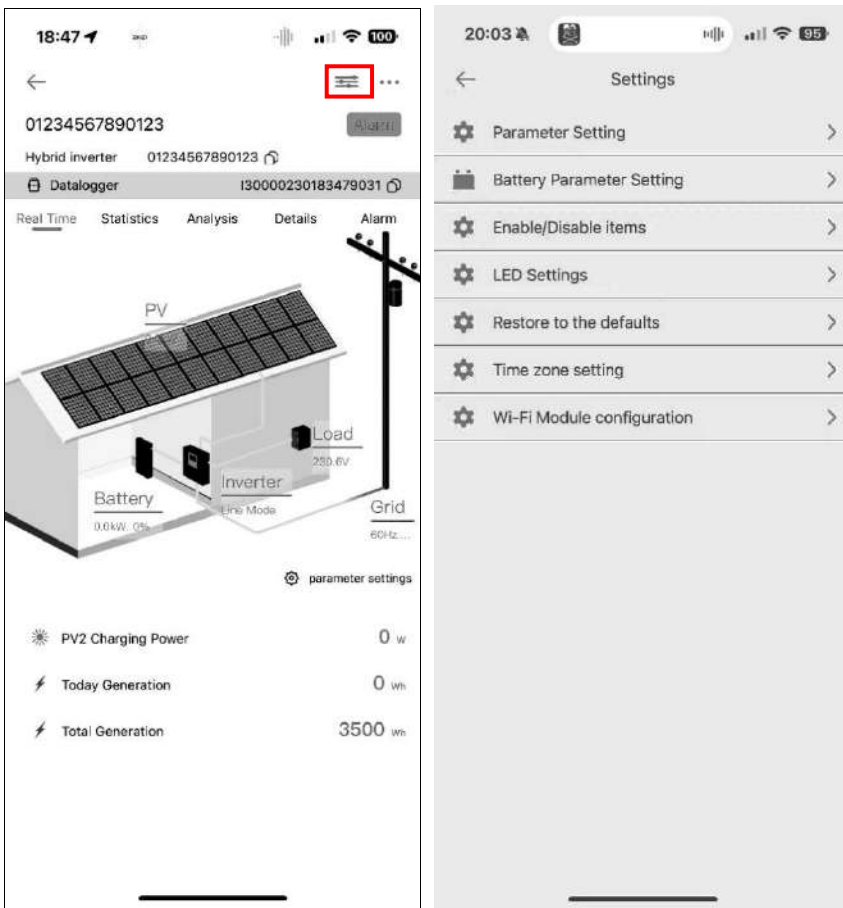

- Click "Real Time" to see the inverter real-time data. Click "parameter settings" to choose data you want to see on the real time page. You can choose up to **10 data**.

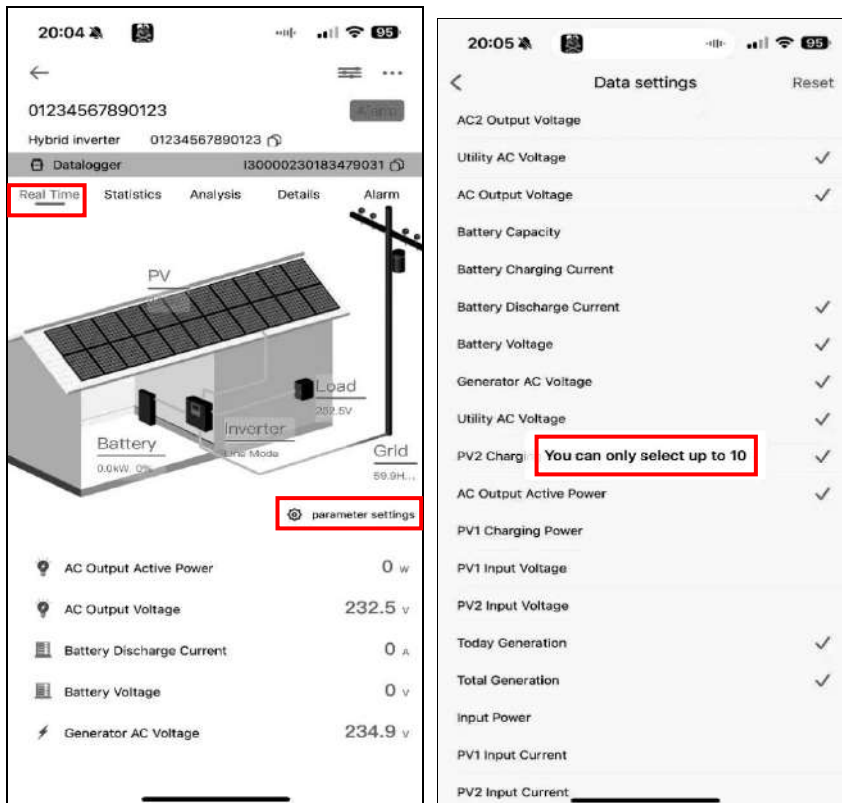

- Click "Statistics" to see the inverter solar power per hour, day, month and year.
Day: Click the button to query the hourly power generation data of the current day.

Month: Click the button to query the daily power generation data of the current month.

Year: Click the button to query the monthly power generation data of the current year.

Total: Click the button to query the annual power generation data.

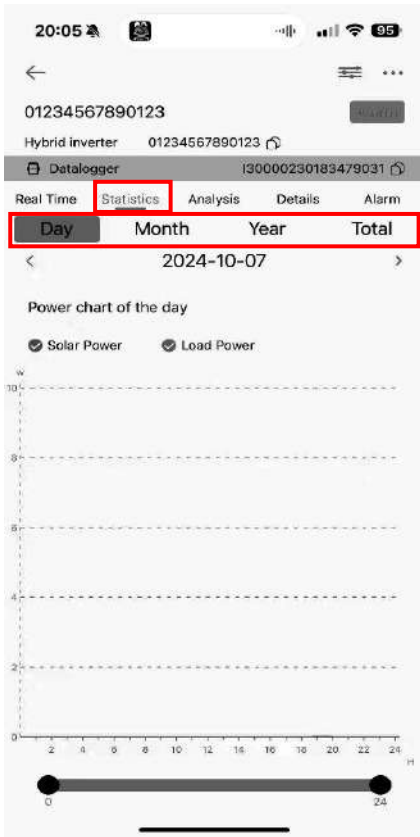

- Click "Analysis" to see the inverter data per hour. Click "SelectedXTerm" to choose the data you want to compare. You can choose up to **2 different units** such as energy (kWh) and current (A).

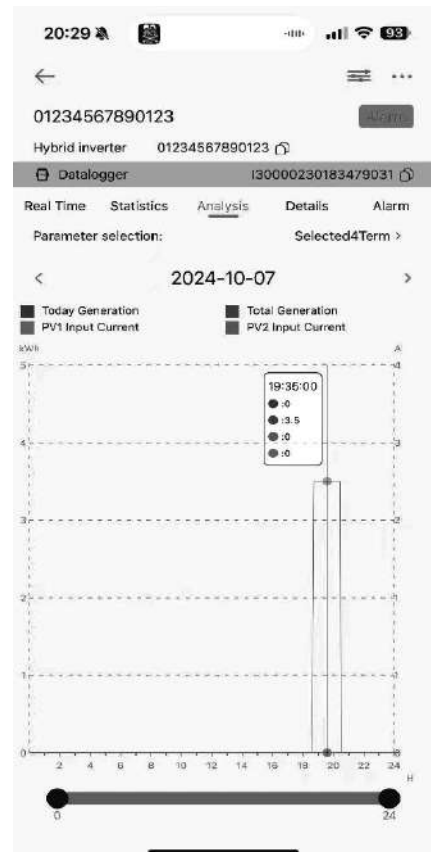
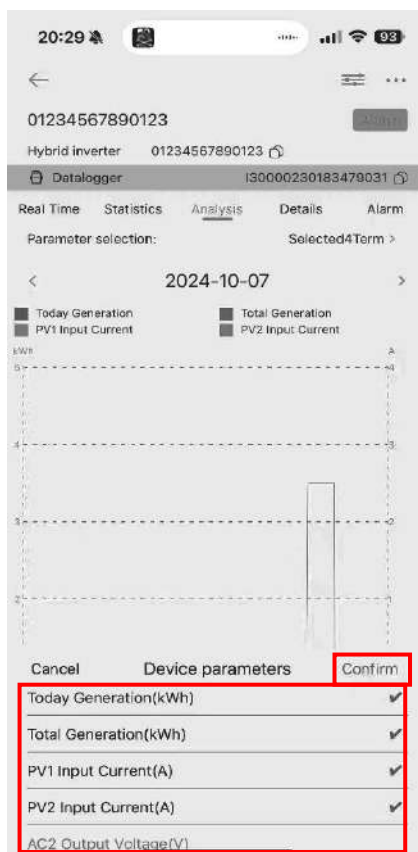
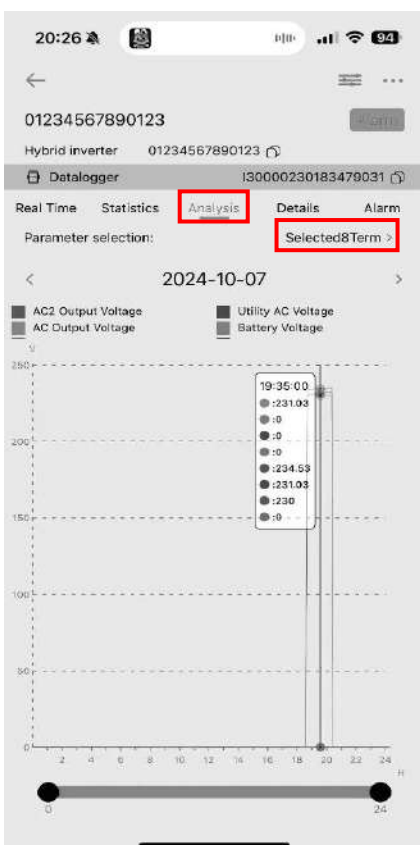

- Click "Details" to see the inverter history.

Timestamp	Data name	Data
20:02:03	SN	01234567890123
19:57:14	Main CPU Firmware Version	00001.91
19:52:24	Secondary CPU Firmware Version	00097.03
19:47:34	Input Relay CPU Version	54.01
19:42:44	Utility AC Voltage	0.0V
19:25:23	Utility AC Frequency	0.0Hz
19:20:43	Generator AC Voltage	234.9V
19:15:53	Generator AC Frequency	59.9Hz
19:11:03	PV1 Input Voltage	0.0V
19:08:13	PV2 Input Voltage	0.0V
19:01:23	PV1 Charging Power	0W
18:56:34	PV2 Charging Power	0W
18:51:44	Battery Voltage	0.0V
18:46:54	Battery Capacity	0%
18:41:55	Battery Charging Current	0A
18:36:55	Battery Discharge Current	0A
18:31:55	AC Output Voltage	232.5V
18:26:55	AC Output Frequency	59.9Hz
18:21:55	AC Output Apparent Power	0VA
18:16:55	AC Output Active Power	0W
18:11:55	Output Load Percent	0%
18:06:55	Grid Rating Voltage	230.0V

- Click "Alarm" to see the inverter warning and fault.

Alarm Type	Alarm Code	Timestamp
PV Loss	0x00000001	2024-10-07 19:34:44
Bat Open	0x00000001	2024-10-07 19:34:44
Battery Weak	0x00000001	2024-10-07 19:34:44

Alarm

- Choose Alarm page to see the warning and fault list of all inverters.



Me

- Choose Me page to see account information and app version.
- Click "Username" to modify nick name and password, and check if the mail has been bound. If the mail is bound, you can retrieve password through mail.